



VENTURE  
LIGHTING

# CANADIAN 2024 CATALOG



LED • CONTROLS • HID

# VALUE • FLEXIBILITY • PERFORMANCE



## CONTENTS

**Introduction** ..... 2-3

**Interior Lighting Solutions**

- Panels ..... 5-7
- Highbays ..... 8-10
- Lowbay ..... 11
- Vapor Tight ..... 12
- Recessed Downlights ..... 13
- Wrap Fixture ..... 14
- Linear Strip Fixtures ..... 15
- Temporary Lighting ..... 16

**Exterior Lighting Solutions**

- Area ..... 18-21
- Wallpacks ..... 22
- Floods ..... 23-24
- Canopy ..... 25
- Recessed Canopy ..... 26
- Gas Station Canopy ..... 27
- Garage Lights ..... 28

**Tennis/Pickleball Lighting Solutions**

- Tennis/Pickleball Lighting 30-31

**LED Lamps**

- Retrofit Lamps ..... 33-35

**Wireless Controls & Sensors**

- Sensors and Controls ... 37-39

**Pole Accessories**

- Area Lighting Pole Options 41-49
- Accessories for Pole Options 50-51

**HID Lighting Solutions**

- Metal Halide Lamps .... 53-54
- SPL Long Life Lamps ..... 55
- Sports Lighting Lamps ..... 55
- Energy Master Lamps ..... 55
- Natural White Lamps ..... 56
- White-Lux HPS Retrofit ..... 56
- Double Ended Lamps ..... 56
- High Pressure Sodium Lamps 57
- HID Ballasts ..... 58
- Capacitors ..... 58
- Replacement Igniters ..... 58

**HID Technical Information** 59-62

**Warranty Information** ..... 63

Venture Lighting is a worldwide innovator, manufacturer and supplier of energy efficient lighting materials, components, systems, fixtures and controls. Since being founded in 1983 and becoming part of Advanced Lighting Technologies in 1995, Venture Lighting has always been a pioneer in light source technologies. An advocate for industry terms like "LPW" and "Lumen Maintenance", Venture Lighting continues to be a leader in the lighting industry.

### An Innovation Leader:

- Full line of LED lamps, luminaires and controls
- Low glare
- High efficacy
- Thermal management
- Precise optics
- Fixtures that are application adaptable

### Customers are assured:

- The very best technology
- The highest level of service
- Ease of working with
- Dedicated technical and customer support

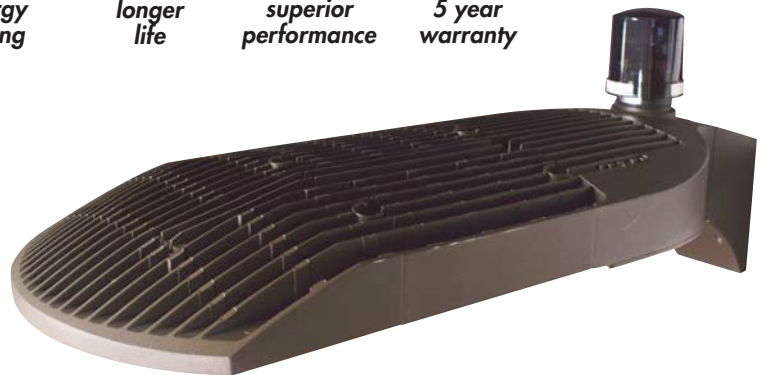

**F**ounded in 1983, Venture has built a reputation as the market leader in LED lighting and Metal Halide technology. We are innovators, manufacturers and suppliers of energy-efficient luminaires, lighting components and control systems.

Venture continuously strives to offer its customers, large and small, the best lighting solutions coupled with the very best service and support. Venture has built strong customer relationships that have lasted through the years because of its dynamic and broad product lines combined with a level of customer service and technical support teams unequaled in the industry.

With over 35 years of pioneering light source technologies, Venture Lighting is an innovation-driven designer, manufacturer and marketer of energy efficient lighting products, and services. Transforming the high intensity discharge lighting industry, Venture Lighting's superb quality, world-class service and outstanding technical support continues in the very best LED lighting solutions paired with a best-in-class wireless control system and the highest level of dedicated technical and customer support on all of their products.

Visit [VentureLighting.com](http://VentureLighting.com) to find out more about Venture Lighting.



## ASSEMBLING AT VENTURE LIGHTING, NORTH AMERICA

Venture Lighting is assembling its LED luminaires in the North America. Currently, Venture Lighting is assembling two different LED product families: Low watt Environ area lighting and VFlood area lighting. Venture Lighting has always strived to exceed customer expectations. Venture believes that assembling luminaries in North America will allow Venture to provide customers with more options and faster delivery times.



### The Results

- Faster delivery time
- American quality and know-how
- More factory-installed options
- Made-to-order specifications
- Building for a better, brighter future

Visit [Venture's YouTube Channel](#) to watch a short video of the production of LED Highbays in Solon, Ohio.



# INTERIOR LIGHTING SOLUTIONS



Select-Pro® LED Panels



## Select-Pro® Back-Lit Panel

Order Code/ DLC Model Number	Size	3500K			4000K			5000K			CRI	Life hours†	Fixt. Color	DLC Qualified
		Wattage	Lumen Output	LPW	Lumen Output	LPW	Lumen Output	LPW						
PB224-45-UNV-C&W	2x4	45	5150	114	5350	119	5250	117	≥80	50,000	White	Standard		
		35	4000	114	4150	119	4050	116						
		30	3400	113	3550	118	3500	117						
PB222-35-UNV-C&W	2x2	35	3950	113	4200	120	4050	116	≥80	50,000	White	Standard		
		30	3400	113	3600	120	3450	115						
		20	2250	113	2400	120	2300	115						
PB114-35-UNV-C&W	1x4	35	3900	111	4150	119	4000	114	≥80	50,000	White	Standard		
		30	3300	110	3550	118	3400	113						
		20	2200	110	2350	118	2250	113						

NOTE: † Lumen maintenance data is based on LED testing per IESNA LM-80 and projected per IESNA TM-21

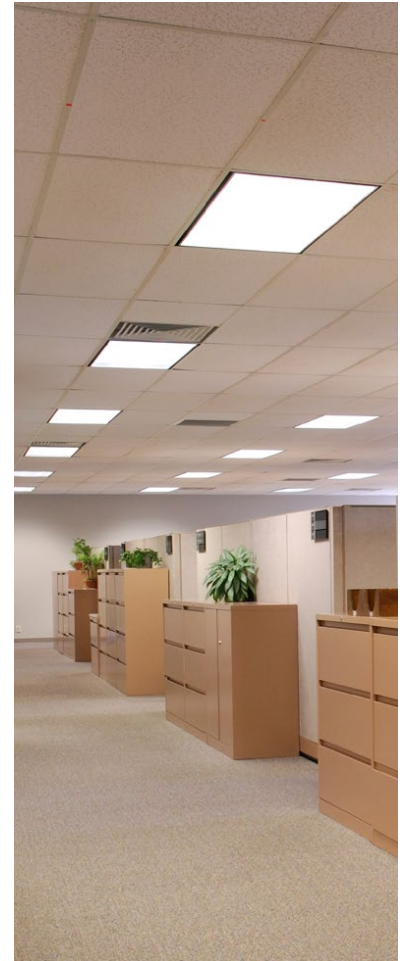

## Select-Pro® High Lumen Back-Lit Panel

Order Code/ DLC Model Number	Size	3500K			4000K			5000K			CRI	Life hours†	Fixt. Color	DLC Qualified
		Wattage	Lumen Output	LPW	Lumen Output	LPW	Lumen Output	LPW						
PB124-50-UNV-C&W-H	2x4	50	6100	122	6400	128	6200	124	≥80	50,000	White	Premium		
		45	5700	127	6000	133	5900	131						
		40	5000	125	5200	130	5100	128						
PB122-40-UNV-C&W-H	2x2	40	5000	125	5400	135	5100	128	≥80	50,000	White	Premium		
		30	3900	130	4100	137	4000	133						
		25	3300	132	3450	138	3400	136						

NOTE: † Lumen maintenance data is based on LED testing per IESNA LM-80 and projected per IESNA TM-21

### Dimensions

Description	Length (A)	Width (B)	Height (C)	Weight
45W 2x4	47.76"	23.76"	1.66"	9.45 lbs
50W 2x4, High Lumens	47.74"	23.74"	1.48"	7.72 lbs
35W 2x2	23.76"	23.76"	1.66"	5.35 lbs
40W 2x2, High Lumens	23.74"	23.74"	1.48"	4.30 lbs
35W 1x4	47.76"	11.81"	1.66"	4.75 lbs

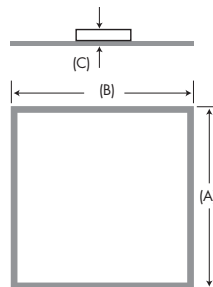

### Accessories (Order as separate line items)

- KT23281** - Battery back-up kit for 1x4
- KT23279** - Battery back-up kit for 2x2, 2x4
- KT14136** - 1x4 Drywall mount kit, white
- KT48110** - 1x4 Surface mount kit, white
- KT18101** - 2x2 Drywall mount kit, white
- KT48112** - 2x2 Surface mount kit, white
- KT18916** - 2x4 Drywall mount kit, white
- KT48114** - 2x4 Surface mount kit, white
- AC25420** - 3/8" 3-Wire 14/3 6ft Flex Whip
- AC25418** - 3/8" 4-Wire 14/4 6ft Flex Whip
- AC25425** - 3/8" 5-Wire 18/3, 18/2 6ft Flex Whip
- AC25426** - 3/8" 6-Wire 18/4, 18/2 6ft Flex Whip

Add suffix "-EM" to order code for a factory installed Battery Backup.  
Add suffix "-WP" to order code for a factory installed 6ft Whip.



# LED PANEL



Venture's Select-Pro™ Edge-Lit LED Panels  
Available in 2x4, 2x2 and 1x4

## LED Select-Pro® Panels

Venture Lighting's Select-Pro™ edge-lit LED panels are low profile, lightweight, and designed for long life and low maintenance. These thin luminaires are designed to quickly and easily upgrade existing fluorescent fixtures and be more versatile than other LED panels. The high performance LED source is mounted to ensure proper thermal management of the system. Each fixture is capable of changing to 3 different CCT settings (3500K, 4000K, 5000K) and 3 different wattage settings (3 light levels) with a simple slide switch. The flexible selection capability allows for a cost effective method to reduce stocking inventory by 88% (1 SKU instead of 9). All Select-Pro™ panel fixtures are preset to the highest wattage and 4000K CCT.

## Benefits and Features

- Change from 3500K, 4000K or 5000K with just the flip of a switch
- Choose from three different wattages with just the flip of a switch
- Reduce inventory SKUs by 88%
- Easy to install
- Battery back-up option available
- Edge-lit, low glare and easy on the eyes
- Designed for upgrading existing fluorescent fixtures or for new construction
- 0-10V DC dimming standard to maximize energy savings
- Rated for damp and dry locations
- IC Rated
- Universal 120-277V, 50/60Hz input



CCT/Wattage Field Adjustable Switches



3500K

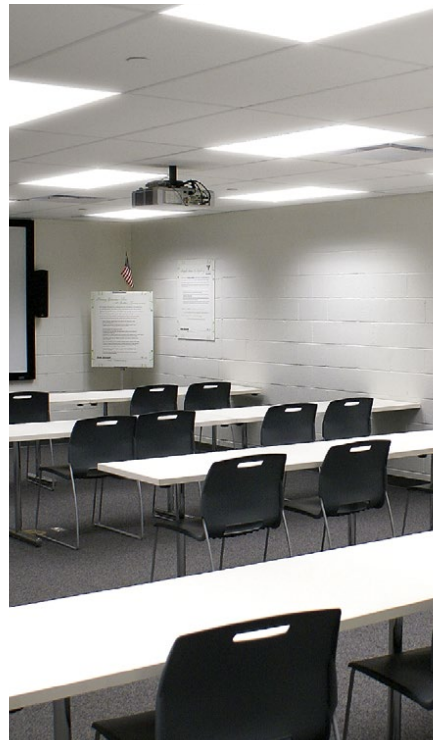

4000K

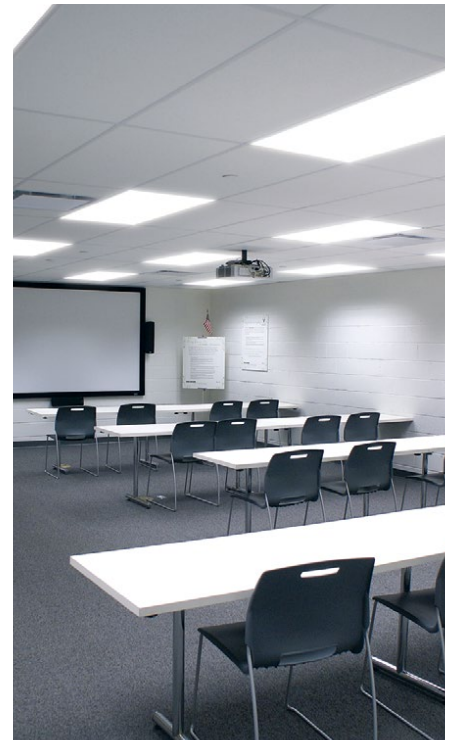

5000K



# LED PANEL

## Select-Pro® Edge-Lit Panel

Order Code/ DLC Model Number	Size	3500K		4000K		5000K		CRI	Life hours†	Fixt. Color	DLC Qualified	
		Wattage	Lumen Output LPW	Lumen Output LPW	Lumen Output LPW							
P424-45-UNV-C&W	2x4	45	5194	115	5583	124	5510	122	≥80	50,000	White	Standard
		35	4097	117	4404	125	4347	124				
		30	3565	118	3832	128	3782	126				
P422-40-UNV-C&W	2x2	40	4660	117	5101	128	4791	120	≥80	50,000	White	Standard
		30	3746	125	4101	137	3852	128				
		25	3370	135	3689	148	3465	139				
P414-40-UNV-C&W	1x4	40	4326	108	4671	117	4378	110	≥80	50,000	White	Standard
		30	3478	116	3755	126	3520	117				
		25	3042	122	3285	131	3079	123				

NOTE: † Lumen maintenance data is based on LED testing per IESNA LM-80 and projected per IESNA TM-21

### Benefits and Features

- Electrical: 120-277V, 50/60Hz
- Edge-lit optics, low glare and easy on the eyes
- 3 different CCT settings: 3500K, 4000K, 5000K
- 3 wattage settings; 3 different light levels
- Simple slide switch, no cumbersome dip switches
- Reduce stocking inventory by 88%; 1 SKU instead of 9
- cETLus Listed
- IP20 Rated for dry and damp locations



### Dimensions

30W-45W 2x4

Weight: 11.6 lbs (5.26 kg)

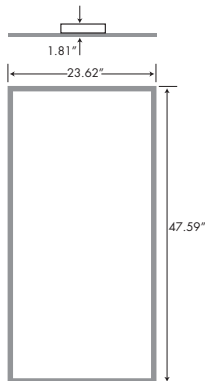

25W-40W 2x2

Weight: 5.75 lbs (2.61 kg)

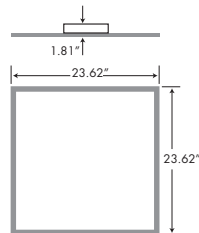

25W-40W 1x4

Weight: 6.42 lbs (2.91 kg)

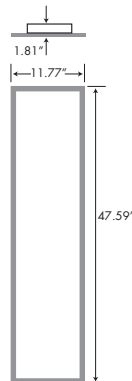

### Accessories (Order as separate line items)

- BB26329** - 7.8W Battery backup
- KT14136** - 1x4 Drywall mount kit, white
- KT20945** - 1x4 Surface mount kit, white
- KT18101** - 2x2 Drywall mount kit, white
- KT14156** - 2x2 Surface mount kit, white
- KT18916** - 2x4 Drywall mount kit, white
- KT18522** - 2x4 Surface mount kit, white
- AC25420** - 3/8" 3-Wire 14/3 6ft. Flex Whip
- AC25418** - 3/8" 4-Wire 14/4 6ft. Flex Whip
- AC25425** - 3/8" 5-Wire 18/3, 18/2 6ft Flex Whip
- AC25426** - 3/8" 6-Wire 18/4, 18/2 6ft Flex Whip

Add suffix "-EM" to order code for a factory installed Battery Backup.

Add suffix "-WP" to order code for a factory installed 6ft Whip.

Add suffix "-PP" to order code for a factory installed PowPack.



# LED HIGHBAY LIGHTING

## VSplash

Order Code	Dia. (in)	Wattage	Lumen Output	Color Temp.	CRI	Life Hours†	Fix. Color	Dimming Leads	Replaces Existing HID Wattage	DLC Qualified	DLC/NSF Model Number
HB45236	19.3	150W	21500	5000K	≥80	230,000	Gray	External	Up to 400W	Premium	HW1-150C-AB
HB41357	19.3	150W	21500	5000K	≥80	230,000	Gray	Internal (capped)	Up to 400W	Premium	HW1-150C-AB

NOTE: † Lumen maintenance data is based on LED testing per IESNA LM-80 and projected per IESNA TM-21

## Benefits and Features

- Electrical: 120-277V, 50/60Hz
- Efficacy up to 143 lumens per watt
- Polycarbonate lens; safe for food processing applications
- No external reflectors required
- Body and mounting loop are aluminum alloy; stainless steel hardware
- Operating temperature range of -40°C to +40°C
- Superior temperature stability
- Temperature tested at toughest conditions
- Beam angle: 90° standard; optional 50° and 120° beam angles available
- White fixture color option available
- cULus Listed
- IP69K Rated
- NSF Certified



## Photometrics

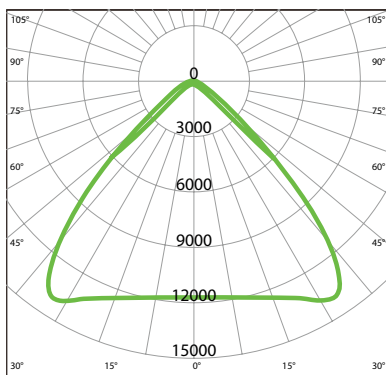

## Dimensions

Weight: 14.8 lbs (6.7 kg)

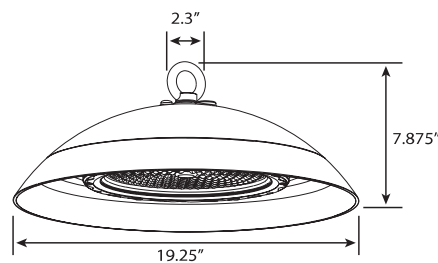

## Accessories (Order as separate line items)

- AC78126 - Pendant mount kit - wire outside
- LN13632 - 120° clear plastic flat lens
- LN13492 - 120° frosted plastic lens
- LN13421 - 120° clear tempered glass lens
- LN28431 - 50° clear plastic lens

Factory installed indoor and NSF certified watertight plug options are available, see spec sheets for details



NEMA L5-15P  
For 120V Input



NEMA L18-20P  
For 208V Input



NEMA L6-15P  
For 240V Input



NEMA L7-15P  
For 277V Input





# LED LINEAR HIGHBAY LIGHTING

## Select-Pro® Linear Highbay

Order Code	Size	4000K			5000K			Rated Life Hours <sup>†</sup>	Replaces Existing HID Luminaire	Fixt. Color	DLC Qualified
		Wattage	Lumen Output	LPW	Lumen Output	LPW	CRI				
HB38124	2'	210	28350	135	28560	136	≥80	50,000	Up to 1000W	White	Premium
		170	22950	135	23120	136					
		155	20925	135	21080	136					
HB21925	2'	155	20925	135	21080	136	≥80	50,000	Up to 400W	White	Premium
		130	17550	135	17680	136					
		105	14175	135	14280	136					

NOTE: † Lumen maintenance data is based on LED testing per IESNA LM-80 and projected per IESNA TM-21

### Benefits and Features

- Electrical: 120-277V, 50/60Hz
- 0-10VDC continuous dimming
- Frosted lens for diffused light distribution
- CCT and power selectable for application flexibility
- Versatile and easy to install - pendant or surface mount accessories sold separately
- Factory installed battery back-up available
- Screw-in sensor ready
- Optional wire guard available
- Rated for damp and dry locations
- cULus Listed

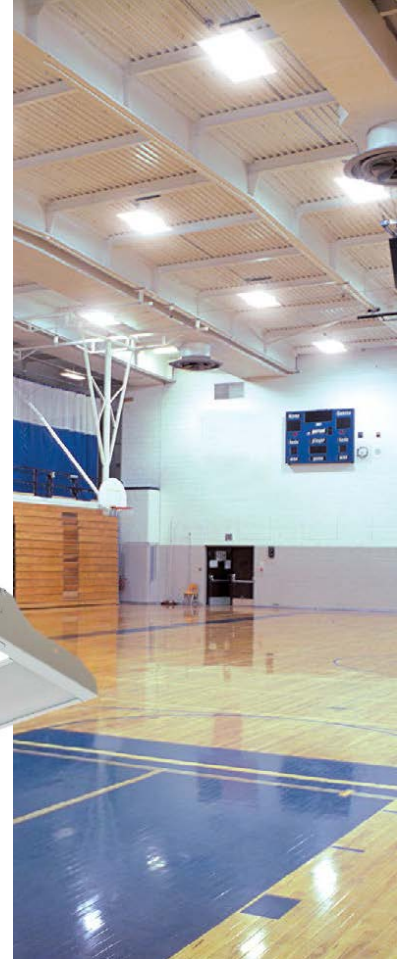

### Dimensions

105W-155W

Weight: 12.57 lbs (5.70 kg)

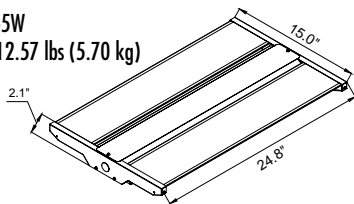

155W-210W

Weight: 13.45 lbs (6.10 kg)

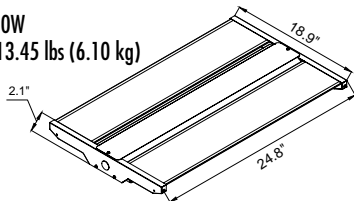

### Accessories (Order as separate line items)

- PH86347 - 12VDC Microwave Sensor, Motion/Photosensor/Dimming, External plug-in
- AC86350 - Wireless Sensor Programming Tool
- KT26750 - Pendant mount kit with hardware
- KT26740 - Surface mount kit
- KT26822 - Wire guard kit with hardware for 105-155W
- KT26824 - Wire guard kit with hardware for 155-210W
- KT26103 - Battery back-up kit
- AC25420 - 3/8" 3-Wire 14/3 6ft Flex Whip
- AC25418 - 3/8" 4-Wire 14/4 6ft Flex Whip
- AC25425 - 3/8" 5-Wire 18/3, 18/2 6ft Flex Whip
- AC25426 - 3/8" 6-Wire 18/4, 18/2 6ft Flex Whip

Add suffix "-EM" to order code for a factory installed Battery Backup.  
Add suffix "-WP" to order code for a factory installed 6ft Whip.  
Factory installed plug options are available, see spec sheets for details.



NEMA L5-15P  
For 120V Input



NEMA L18-20P  
For 208V Input



NEMA L6-15P  
For 240V Input



NEMA L7-15P  
For 277V Input



# LED HIGHBAY LIGHTING

## Select-Pro® Modern Highbay

Order Code	Dia. (inch)	4000K			5000K			Beam Angle	Lumen Maint. @50,000 hrs†	Calc. L70@25°C Amb.(hrs)†	Fixt. Color	DLC Qualified	DLC/NSF Model Number
		Wattage	Lumen Output	LPW	Wattage	Lumen Output	LPW						
HB48133	14.8	240	34800	145	32400	135	≥80	90°	90.25%	174,000	White	Premium	HBRSA-240/200/ 180WS1BTZA1- WH40/50KWR
		200	29000	145	27000	135							
		180	26100	145	24300	135							
HB32609	12.6	150	21750	145	20250	135	≥80	90°	90.25%	174,000	White	Premium	HBRSA-150/120/ 100WS1BTZA1- WH40/50KWR
		120	17400	145	16200	135							
		100	14500	145	13500	135							

NOTE: † Lumen maintenance data is based on LED testing per IESNA LM-80 and projected per IESNA TM-21

### Benefits and Features

- Electrical: 120-277V, 50/60Hz
- 0-10VDC continuous dimming
- High quality Sosen driver; Lumileds LEDs
- CCT and power selectable for application flexibility
- Polycarbonate circular ribbed lens for glare reduction
- cULus Listed; IP69K Rated; NSF Certified - Splash Zone



### Dimensions

100W-150W: Weight: 6.2 lbs (2.81 kg)

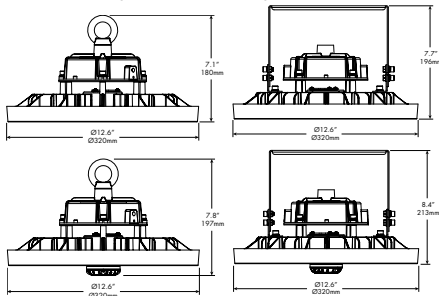

180W-240W: Weight: 9.4 lbs (4.26 kg)

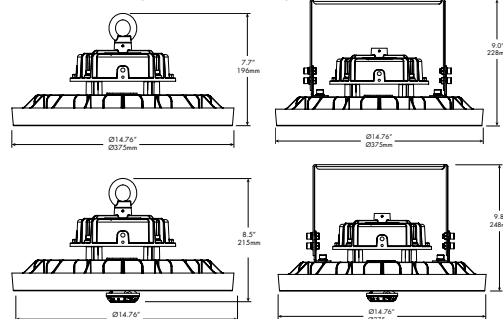

### Accessories (Order as separate line items)

- BB27128** - 40W Battery backup
- PH53207** - 12VDC Microwave Sensor, Motion/Photosensor/Dimming, External plug-in
- PH52186** - Wireless Sensor Programming Tool
- SP12714** - Remote mount surge protector

### Accessories (Order as separate line items)

#### Accessories for 100-150W Modern

- LN31732** - 120° clear PC lens
- LN31734** - 120° frosted PC lens
- RF14210** - PC reflector
- RF14230** - Aluminum reflector
- AC27385** - Surface mount bracket, white
- AC27485** - 3/4" NPT Pendant adaptor (M10)

### Accessories (Order as separate line items)

#### Accessories for 180-240W Modern

- LN31736** - 120° clear PC lens
- LN31738** - 120° frosted PC lens
- RF14220** - PC reflector
- RF14240** - Aluminum reflector
- AC27390** - Surface mount bracket, white
- AC27490** - 3/4" NPT Pendant adaptor (M12)

Factory installed Indoor and NSF certified watertight plug options are available, see spec sheets for details.



NEMA L5-15P  
For 120V Input



NEMA L18-20P  
For 208V Input



NEMA L6-15P  
For 240V Input



NEMA L7-15P  
For 277V Input



## Select-Pro® VSlim Lowbay

Order Code	Size	3500K			4000K			5000K			Lumen Maint. @50,000 hrs <sup>†</sup>	Calc. L70@25°C Amb.(hrs) <sup>†</sup>	Fixt. Color	DLC Qualified	DLC Model Number
		Wattage	Lumen Output	LPW	Lumen Output	LPW	Lumen Output	LPW	CRI						
SM42709	4'	45	5895	131	5940	132	5985	133	≥80	91%	190,000	White	Standard	SM5-4H-45/38/34-D835/40/50(-EM, -S)	
		38	5206	137	5244	138	5282	139							
		34	4760	140	4794	141	4828	142							

NOTE: † Lumen maintenance data is based on LED testing per IESNA LM-80 and projected per IESNA TM-21

### Benefits and Features

- Electrical: 120-277V, 50/60Hz
- 1-10VDC continuous dimming capability is standard
- Field-adjustable CCT & wattage
- 3 CCT settings: 3500K/4000K/5000K
- 3 wattage settings; 3 light levels
- Low glare, frosted lens
- Multiple factory installed options, such as motion sensors, battery back-ups and whips
- Suitable for surface or suspension mount applications
- cULus Listed; damp location rated



### Accessories (Order as separate line items)

- PH41623 - Motion only control sensor
- PH77409 - Motion/PhotoCell/Dim control sensor
- AC13858 - V-hooks
- AC13812 - V-hooks & surface mount clips
- AC20156 - V-hooks with 6ft chains
- AC35187 - Row alignment accessory
- KT12139 - 4ft wire guard kit
- LN18733 - 4ft replacement lens, acrylic
- AC25420 - 3/8" 3-Wire 14/3 6ft Flex Whip
- AC25418 - 3/8" 4-Wire 14/4 6ft Flex Whip
- AC25425 - 3/8" 5-Wire 18/3, 18/2 6ft Flex Whip
- AC25426 - 3/8" 6-Wire 18/4, 18/2 6ft Flex Whip

Add suffix "-EM" to order code for a factory installed fixture with battery back-up.  
 Add suffix "-S1" to order code for a factory installed fixture with a motion only sensor (Part #PH41623).  
 Add suffix "-S2" to order code for a factory installed fixture with a motion/ photocell/dim sensor (Part #PH77409).  
 Add suffix "-WP1" to order code for a factory installed 6ft 3-wire whip, installed on end of fixture (Part #AC25420).  
 Add suffix "-WP2" to order code for a factory installed 6ft 3-wire whip, installed on back of fixture (Part #AC25420).

### Photometrics

34W-45W 4FT Select-Pro™ VSlim Lowbay

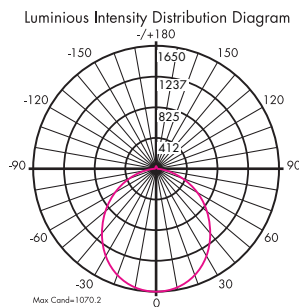

### Dimensions

34W-45W 4FT: Weight: 4.5 lbs (2.05 kg)

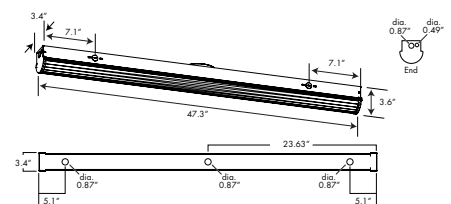

# LED LINEAR LIGHTING

## Select-Pro® Vapor Tight

3500K 4000K 5000K

Order Code	Size	Wattage	Lumen Output	Lumen Output	Lumen Output	Lumen Maint. CRI	Calc. L70@25°C @50,000 hours†	Fixt. Color	DLC Qualified	DLC Model Number	
VP38410	4'	45	5985	6435	6075	≥80	90%	163,000	Gray	Standard	VP4SA2-45/38/34-835/40/50
		38	5282	5662	5358						
		34	4828	5168	4896						
VP74127	8'	90	11970	12870	12150	≥80	90%	163,000	Gray	Standard	VP8SA-90/75/60-835/40/50
		75	10425	11175	10575						
		65	9230	9880	9360						

NOTE: † Lumen maintenance data is based on LED testing per IESNA LM-80 and projected per IESNA TM-21

### Benefits and Features

- Electrical 120-277V, 50/60Hz
- Field-adjustable CCT & wattage
- Slim fixture design
- Factory installed battery back-up option available
- cULus Listed
- IP65 Rated - suitable for wet locations
- NEMA Type 4X enclosure rating
- 5VA Flame Rating
- Integrated lens and LED tray for simplified installation



### Dimensions

34W-45W 4FT: Weight: 4.41 lbs (2.0 kg)



65W-90W 8FT: Weight: 7.9 lbs (3.58 kg)

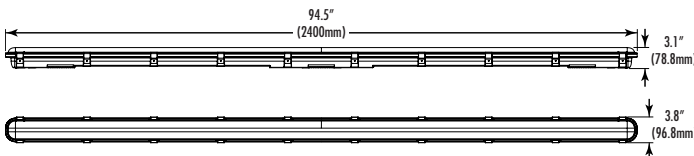

### Accessories (Order as separate line items)

- PH58143 - Wet rated motion only control sensor - long extension
- PH52171 - Wet rated motion/photocell/dimming control sensor - long extension
- SP12714 - 120-277V Surge protector

Add suffix "-EM" to order code for a factory installed Battery Backup.



# LED RECESSED DOWNLIGHT

## Downlight Retrofit Kit

Order Code	Dia.	Wattage	Lumen Output	Color Temp.	CRI	Rate Life (hrs)	Beam Angle	Amp. Draw (A)		Replaces Existing			Energy Star Model Number
								120V	277V	CFL	MH	Trim	
DL38134	6"	18	1318	4000K	80+	35,000	90°	0.15	0.07	32W	70W	White	DLB-1801N-WH
DL38412	6"	18	1318	5000K	80+	54,000	90°	0.15	0.07	32W	70W	White	DLB-1801C-WH
DL38145	6"	18	1318	4000K	80+	54,000	90°	0.15	0.07	32W	70W	Silver	DLB-1801N-SV
DL42017	8"	40	3163	3000K	80+	54,000	90°	0.35	0.16	2x32W	100W	White	DLC-4001W-WH
DL42531	8"	40	3163	5000K	80+	54,000	90°	0.35	0.16	2x32W	100W	White	DLC-4001C-WH
DL20658	8"	54	4100	4000K	80+	35,000	90°	0.48	0.22	2x42W	175W	White	-

## Benefits and Features

- Universal 120-277V, 50/60Hz input
- 0-10VDC dimming standard to maximize energy savings
- Energy saving of up to 75% compared to Compact Fluorescent and Metal Halide
- Upgrade standard CFL and HID 6" or 8" diameter recessed luminaires to high output LED (with 80+ CRI)
- 3X longer life than traditional technology, reducing maintenance costs
- Energy Star Certified (specific models only)
- cULus rated for dry and damp locations
- Lightweight design allows for easy installation
- White and silver trim

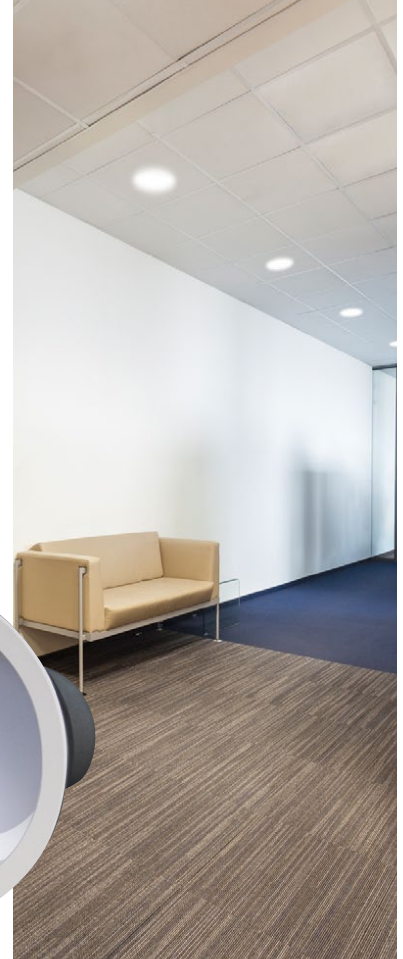

## Photometrics

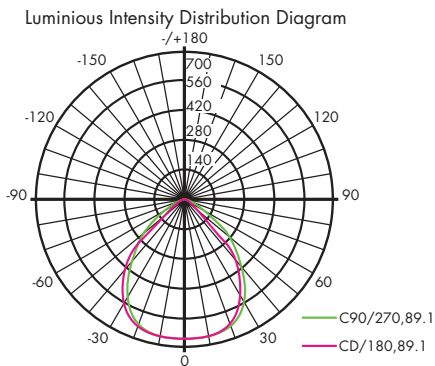

## Dimensions

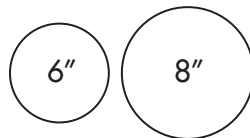
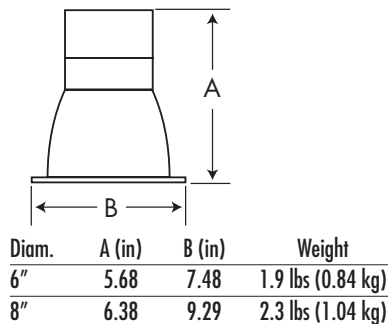

## Accessories (Order as separate line items)

- BB26329 - 7.8W Battery Backup
- KT86415 - New construction kits for 6" downlights
- KT65235 - New construction kits for 8" downlights



# LED LINEAR LIGHTING

## Wrap

Order Code	Size	Wattage	Lumen Output	Color Temp.	CRI	Lumen Maint. @50,000 hours†	Calc. L70@25°C Amb.(hrs)†	Fixt. Color	Replace HID Wattage	DLC Qualified	DLC Model Number
SM29193	4'	40	4640	4000K	≥80	90%	161,000	White	(2) 32W	Standard	SM2-40N8D4-04

NOTE: † Lumen maintenance data is based on LED testing per IESNA LM-80 and projected per IESNA TM-21

## Benefits and Features

- Electrical: 120-277V, 50/60Hz input
- 0-10VDC dimming standard
- cULus Listed; damp location rated



## Photometrics

Luminous Intensity Distribution Diagram

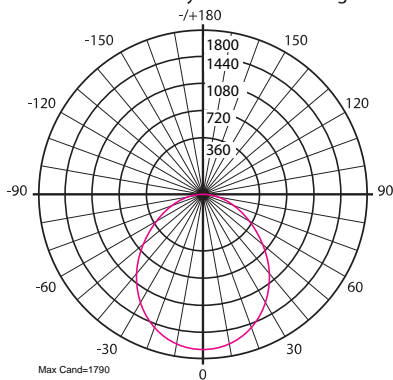

## Dimensions

Weight: 3.75 lbs (1.70 kg)

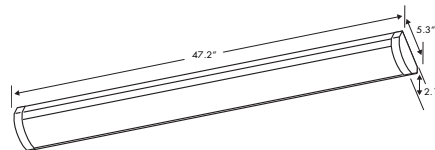

## Accessories (Order as separate line items)

- AC25420 - 3/8" 3-Wire 14/3 Flex Whip
- AC25425 - 3/8" 5-Wire 18/3, 18/2 6ft Flex Whip

Add suffix "-WP" to order code for a factory installed fixture with a 6ft whip (Part #AC25420)



# LED LINEAR STRIP LIGHT

## Select-Pro® Linear Strip

Order Code	Size	3500K			4000K			5000K			Lumen Maint. CRI @50,000 hours†	Calc. L70@25°C Amb.(hrs)†	Fixt. Color	DLC Qualified
		Wattage	Lumen Output	LPW	Lumen Output	LPW	Lumen Output	LPW						
SM10928	4'	45	5895	131	5940	132	5985	133	≥80	91%	190,000	White	Standard	
		38	5206	137	5244	138	5282	139						
		34	4760	140	4794	141	4828	142						
SM08245	8'	90	11790	131	11880	132	11970	133	≥80	91%	190,000	White	Standard	
		72	10412	137	10448	138	10564	139						
		68	9520	140	9588	141	9656	142						

NOTE: † Lumen maintenance data is based on LED testing per IESNA LM-80 and projected per IESNA TM-21

### Benefits and Features

- Electrical: 120-277V, 50/60Hz
- 0-10VDC continuous dimming capability is standard
- Field-adjustable CCT & wattage
- 3 CCT settings: 3500K/4000K/5000K
- 3 wattage settings; 3 light levels
- Low glare, frosted lens
- Multiple factory installed options, such as motion sensors, battery back-ups and whips
- Suitable for surface or suspension mount applications
- SM08245 includes two SM10928 fixtures in a kit
- cULus Listed; damp location rated

### Accessories (Order as separate line items)

- PH41623 - Motion only control sensor
- PH77409 - Motion/Photocell/Dim control sensor
- AC13858 - V-hooks
- AC13812 - V-hooks & surface mount clips
- AC20156 - V-hooks with 6ft chains
- AC35187 - Row alignment accessory
- KT12139 - 4ft wire guard kit, (2) required for 8ft
- LN18733 - 4ft replacement lens, acrylic
- LN18734 - 8ft replacement lens, acrylic
- AC25420 - 3/8" 3-Wire 14/3 6ft Flex Whip
- AC25418 - 3/8" 4-Wire 14/4 6ft Flex Whip
- AC25425 - 3/8" 5-Wire 18/3, 18/2 6ft Flex Whip
- AC25426 - 3/8" 6-Wire 18/4, 18/2 6ft Flex Whip

### Factory Installed Options:

Add suffix "-EM" to order code for a factory installed fixture with battery back-up.

Add suffix "-S1" to order code for a factory installed fixture with a motion only sensor (Part #PH41623).

Add suffix "-S2" to order code for a factory installed fixture with a motion/photocell/dim sensor (Part #PH77409).

Add suffix "-WP1" to order code for a factory installed 6ft 3-wire whip, installed on end of fixture (Part #AC25420).

Add suffix "-WP2" to order code for a factory installed 6ft 3-wire whip, installed on back of fixture (Part #AC25420).



### Photometrics

#### 34W-45W 4FT Select-Pro™ Linear Strip

Luminous Intensity Distribution Diagram

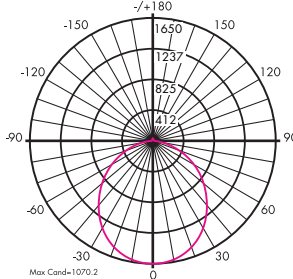

#### 65W-90W 8FT Select-Pro™ Linear Strip

Luminous Intensity Distribution Diagram

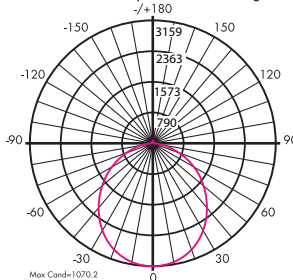

### Dimensions

#### 34W-45W 4FT: Weight: 4.5 lbs (2.05 kg)

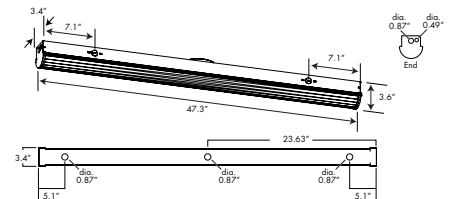

#### 65W-90W 8FT: Weight: 9.0 lbs (4.1 kg)

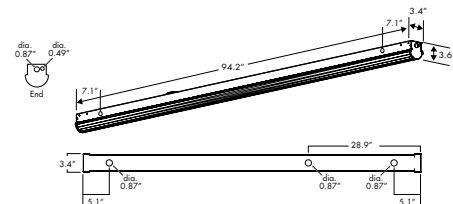

# LED TEMPORARY WORK LIGHT

## Temporary Lighting

Order Code	Wattage	Lumen Output	LPW	Color Temp.	CRI	Beam Angle	Life Hours	Amp. Draw (A) 120V	Fixt. Color	Mounting
SM20896	100	12500	125	5000K	≥80	360°	50,000	0.85	Orange	hook (carabiner style)

### Benefits and Features

- Energy savings of up to 75%, compared to Compact Fluorescent and Metal Halide
- Perfect for construction sites, warehouses, factories, exhibition halls, workshops and more
- 3X longer life than traditional technology, reducing maintenance costs
- UL Listed
- IP64 Rated
- Lightweight design allows for easy installation
- The power supply accepts 120V 60Hz input
- Each fixture supplied with SJTOW 9 foot cord with NEMA 5-15 straight blade plug
- Supplied with hook with spring clip
- Operating temperature of -20°C to 40°C
- Protective wire guard
- Glass-free construction
- Each fixture is linkable via the integrated receptacle
- Link up to 11 fixtures



Linkable by built in receptacle



NEMA 5-15 straight blade plug



### Photometrics

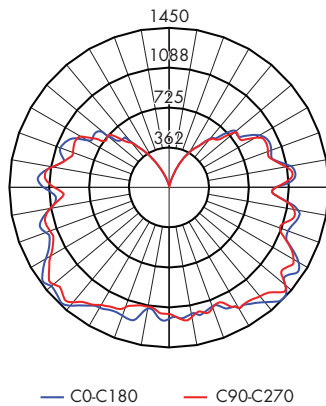

### Dimensions

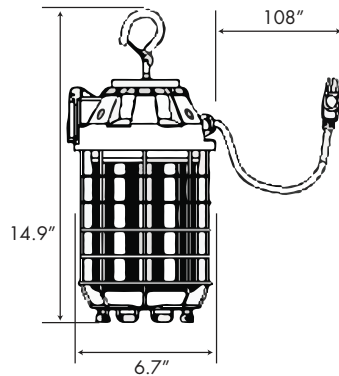



# EXTERIOR LIGHTING SOLUTIONS



*Select-Pro® LED Area Light*



# LED AREA LIGHTING

Venture Lighting's color temperature selectable and wattage selectable LED Area Light is capable of changing to 3 different CCT settings (3000K, 4000K, 5000K) and 3 different wattage settings (3 light levels) with a simple switch. These field-adjustable fixtures are preset to the highest wattage and 5000K CCT. The flexible selection capability allows for a cost-effective method to reduce stocking inventory by 88% (1 SKU instead of 9). This is an ideal choice for commercial, industrial, or retail applications.

## Select-Pro® Area Lights Ordering & Model Number Information

Choose nomenclature that suits application. Example: **AR1-300WT3-ABZ**

<b>AR1</b> -	<b>300</b>	<b>W</b>	<b>T3</b>	-	<b>A</b>	<b>BZ</b> -
<b>Series</b>	<b>Wattage</b>	<b>CCT</b>	<b>Distribution</b>	<b>Voltage</b>	<b>Finish</b>	<b>Accessory</b>

AR1 - Select-Pro LED Area Fixture  150-100/120/150W  300-200/250/300W  W- CCT Selectable  T3-Type 3  T5-Type 5  A-120-277V  BZ-Bronze  Blank-None  SF-Adjustable Slipfitter  RS-Round Square Arm  UB-U-Bracket

## Performance Data

Wattage	Distribution Type	BUG	3000K Lumens	4000K Lumens	5000K Lumens	DLC Model Number	CRI	Lumen Maint. @50,000 hours†	Calc. L70@25°C Amb.(hrs)†
100W	Type 3	B3-U0-G3	12,443	13,672	13,531	AR1UNV-150WT3-BZW50	≥70	90%	169,000
	Type 5	B4-U0-G5	12,362	13,395	13,153	AR1UNV-150WT5-BZW50			
120W	Type 3	B3-U0-G3	14,932	16,407	16,237	AR1UNV-150WT3-BZW50			
	Type 5	B4-U0-G5	14,834	16,074	15,784	AR1UNV-150WT5-BZW50			
150W	Type 3	B3-U0-G3	18,665	20,509	20,296	AR1UNV-150WT3-BZW50			
	Type 5	B4-U0-G5	18,543	20,093	19,729	AR1UNV-150WT5-BZW50			
200W	Type 3	B4-U0-G4	25,213	27,608	27,437	AR1UNV-300WT3-BZW50	≥70	90%	169,000
	Type 5	B5-U0-G2	25,121	27,021	26,527	AR1UNV-300WT5-BZW50			
250W	Type 3	B4-U0-G4	31,516	34,510	34,296	AR1UNV-300WT3-BZW50			
	Type 5	B5-U0-G2	31,402	33,777	33,159	AR1UNV-300WT5-BZW50			
300W	Type 3	B4-U0-G4	37,820	41,413	41,155	AR1UNV-300WT3-BZW50			
	Type 5	B5-U0-G2	37,682	40,532	39,791	AR1UNV-300WT5-BZW50			

NOTE: † Lumen maintenance data is based on LED testing per IESNA LM-80 and projected per IESNA TM-21



## Photometrics

Fixtures mounted at 30 feet. Grid is multiples of mounting height.

150W T3

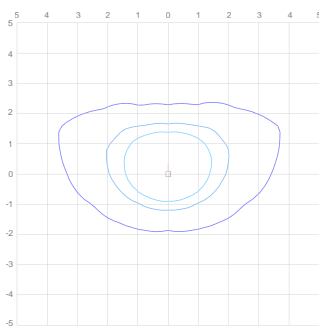

150W T5

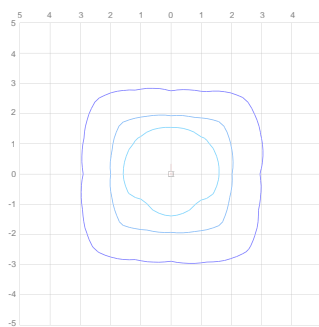

300W T3

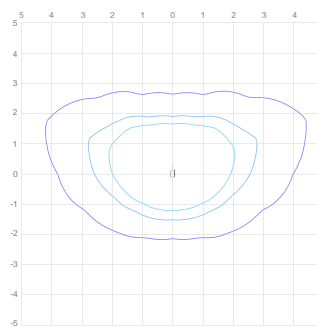

300W T5

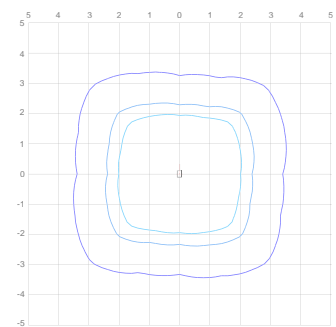

## Accessories (Order as separate line items)

### Mounting Accessories

- AC17341 - 100-300W Adjustable slipfitter
- AC17343 - 100-150W U-bracket
- AC17345 - 200-300W U-bracket
- AC17347 - 100-300W Round & square pole arm

### Misc. Accessories

- PH12415 - 3-pin Twist lock photocell (120-277V)
- PH81975 - Replacement shorting cap
- PH53207 - 12VDC Microwave Sensor, Motion/Photosensor/Dimming, External plug-in
- PH52186 - Wireless Sensor Programming Tool

- SP12714 - 120-277V surge protector
- AC17622 - Backlight shield for 100-150W, Type 3 distribution only
- AC17624 - Backlight shield for 200-300W, Type 3 distribution only



# LED AREA LIGHTING

## Environ

Venture Lighting's Environ area light fixtures combine a sleek, reliable design with precise ANSI optical distributions to make the ideal upgrade for area/site, roadway, and automotive applications. Perfect for new construction or easy replacement of existing installations.

### Benefits and Features

- Rugged die cast housing with a durable powder coat finish
- Vandal resistant polycarbonate lens
- Optical chamber is sealed and gasketed
- Factory installed motion sensor available
- Each fixture will be supplied with a 7-pin receptacle and a shorting cap
- Operating temperature range of -40°C to +40°C
- 10kA surge protection
- 5 year warranty
- 80% Energy savings
- UL Rated for wet locations
- Universal 120-277V or 347-480V, 50/60Hz input
- 0-10VDC dimming standard to maximize energy savings
- IP65 Rated – Suitable for wet locations



3000K color temperature and fixed mounting must be selected for IDA approval



# LED AREA LIGHTING

## Low Watt Environ

### Ordering & Model Number Information

Choose nomenclature that suits application. Example: **ENV-200CT2-ABZ-SHM12**

<b>ENV - 200</b>	<b>C</b>	<b>T2 - A</b>	<b>BZ - SH</b>	<b>M12</b>			
<b>Fixture Type</b>	<b>Wattage</b>	<b>Color Temp.</b>	<b>Optics</b>	<b>Voltage</b>	<b>Fixture Finish</b>	<b>Shield</b>	<b>Options</b>

- |                          |                                    |  |  |  |                                     |   |  |
|--------------------------|------------------------------------|--|--|--|-------------------------------------|---|--|
| ENV - Environ Area Light | <input type="checkbox"/> 200- 200W | <input type="checkbox"/> W- 3000K<br><input type="checkbox"/> B- 3500K<br><input type="checkbox"/> N- 4000K<br><input type="checkbox"/> C- 5000K | <input type="checkbox"/> T2- Type II<br><input type="checkbox"/> T3- Type III<br><input type="checkbox"/> T4- Type IV<br><input type="checkbox"/> T5- Type V | <input type="checkbox"/> A- 120-277V<br><input type="checkbox"/> B- 347-480V | <input type="checkbox"/> BZ- Bronze | "Blank" - No backlight shield<br><input type="checkbox"/> SH- Backlight Shield' | "Blank" - No motion sensor<br><input type="checkbox"/> M12- 120-277V Motion/Dim/Photocell sensor<br><input type="checkbox"/> M34- 347-480V Motion/Dim/Photocell sensor |
|--------------------------|------------------------------------|--|--|--|-------------------------------------|---|--|

Notes: 7 = For Type II, III and IV only

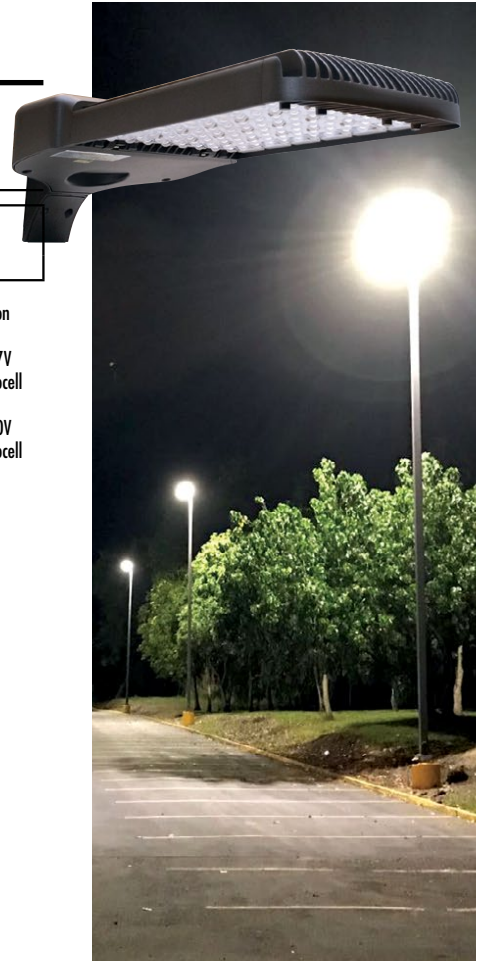

## Performance Data

Wattage	Lumen Output	Color Temp.	CRI	Lumen Maint. @50,000 hours†	Calc. L70@25°C Amb.(hrs)†	Fixture EPA	Color	Replaces Existing HID Wattages
200	23560	3000K	≥70	99%	>500,000	0.78	Bronze	400W V, 1000W H
200	24480	3500K	≥70	99%	>500,000	0.78	Bronze	400W V, 1000W H
200	25400	4000K	≥70	99%	>500,000	0.78	Bronze	400W V, 1000W H
200	25690	5000K	≥70	99%	>500,000	0.78	Bronze	400W V, 1000W H

NOTE: Lumens listed are for Type V distribution

Mounting accessories are ordered separately

† Lumen maintenance data is based on LED testing per IESNA LM-80 and projected per IESNA TM-21

## Photometrics

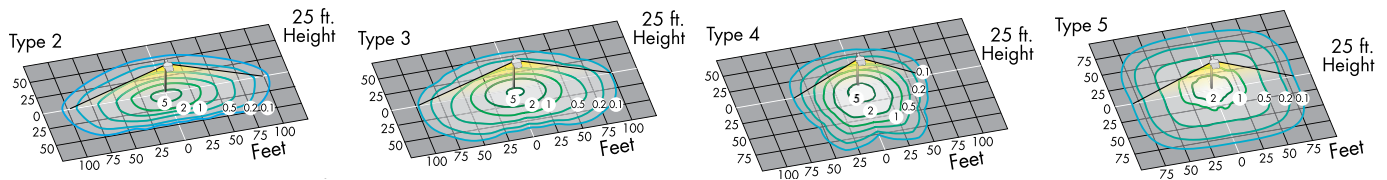

## Accessories (Order as separate line items)

### Mounting Accessories

- EN14178 - Round pole straight arm - bronze
- EN26814 - Square pole mount - bronze
- EN35512 - Adjustable slipfitter - bronze
- EN38419 - Mast arm (hor. tenon) - bronze
- EN47832 - Wall mount - bronze

### Photocell Accessories

- PH12415 - 3-pin twist lock photocell (120-277V)
- PH87145 - 3-pin twist lock photocell (347V)
- PH81156 - 3-pin twist lock photocell (480V)
- PH81975 - Replacement shorting cap

### Miscellaneous Accessories

- SP12714 - 120-277V surge protector
- SP12826 - 347-480V surge protector
- PH46224 - Wireless program tool for M34 options

### Photocell Accessories

- WCN-7P-UNV - Synapse® twist lock controller
- WCG-450 - Synapse® gateway

### Factory Installed Options

- "-SH" - Backlight shield (EN67410)
- "-M12" - Wireless BLE sensor 120-277V (PH43982) + Sensor lens (PH47512)
- "-M34" - Wireless sensor 347-480V (PH52149) + Sensor lens (PH47512)



3000K color temperature and fixed mounting must be selected for IDA approval



# LED AREA LIGHTING

The High Watt Environ fixtures are the ideal fixture for area lighting projects where high performance and precise light distribution is required. The High Watt Environ has been upgraded to 140 lumens per watt (LPW) to increase the delivered light without increasing the required wattage. The higher LPW rating allows for higher light levels without a higher utility bill. This also maximizes the rebate potential with many utilities. In addition to the higher LPW, the Environ fixture light distributions have been redesigned to reduce backlight while providing more light to where it is needed. A Front Row Automotive distribution has been developed specifically to highlight curbside inventory in automotive applications. This distribution, coupled with the other available distributions, provides a complete automotive package.

## High Watt Environ Ordering & Model Number Information

Choose nomenclature that suits application. Example: **ENV2-300A-7CT4-BZP7SH**

ENV2 - 300		A - 7		C		T4 - BZ		P7		SH	
Series	Wattage	Voltage	CRI	CCT	Distribution	Finish	Receptacle	Accessory 1	Accessory 2		

ENV2 - Environ Area Light	<input type="checkbox"/> 300-300W	<input type="checkbox"/> A-120-277V	<input type="checkbox"/> 7-70	<input type="checkbox"/> C-5000K	<input type="checkbox"/> T3-Type 3	<input type="checkbox"/> BZ-Bronze	<input type="checkbox"/> P7-7-Pin (Standard)	<input type="checkbox"/> Blank - None	<input type="checkbox"/> Blank-None
	<input type="checkbox"/> 480-480W	<input type="checkbox"/> B-347-480V		<input type="checkbox"/> N-4000K <sup>1</sup>	<input type="checkbox"/> T4-Type 4	<input type="checkbox"/> BK-Black <sup>1</sup>		<input type="checkbox"/> M1-120-277V <sup>2</sup>	<input type="checkbox"/> SH-Backlight Shield <sup>2</sup>
				<input type="checkbox"/> W-3000K <sup>1</sup>	<input type="checkbox"/> T5-Type 5	<input type="checkbox"/> GR-Gray <sup>1</sup>		Motion Sensor	
					<input type="checkbox"/> TT-Type Tennis	<input type="checkbox"/> WH-White <sup>1</sup>		<input type="checkbox"/> M3-347-480V <sup>2</sup>	
					<input type="checkbox"/> FA-Automotive Front Row			Motion Sensor	

Notes: 1 = Limited Stocked Quantities  
2 = Available on T3, T4, TT, FA Distributions  
3 = Motion/Dim/Photocell Sensor

## Performance Data

Wattage	Distribution Type	BUG	3000K Lumens	4000K Lumens	5000K Lumens	CRI	Lumen Maint. @50,000 hours <sup>1</sup>	Calc. L70@25°C Amb.(hrs) <sup>1</sup>	DLC Qualified	Replaces Existing HID Wattages
300W	Type 3	B3-U3-G5	38,032	39,838	42,896					
	Type 4	B3-U3-G5	38,332	40,153	43,235					
	Type 5	B5-U3-G4	40,192	42,101	45,333	≥70	88%	142,000	Premium	Up to 1000W
	Type T	B3-U3-G3	40,763	42,699	45,976					
	Type FA	B3-U3-G3	40,880	42,822	46,109					
480W	Type 3	B4-U3-G5	60,214	63,074	67,915					
	Type 4	B4-U3-G5	60,690	63,572	68,451					
	Type 5	B5-U3-G5	63,634	66,657	71,773	≥70	88%	142,000	Premium	Up to 1000W
	Type T	B4-U3-G4	64,537	67,603	72,792					
	Type FA	B4-U3-G4	64,724	67,798	73,002					

NOTE: Mounting accessories are ordered separately  
† Lumen maintenance data is based on LED testing per IESNA LM-80 and projected per IESNA TM-21

## Photometrics

480W - 30' mounting height. Divisions are multiples of mounting height.

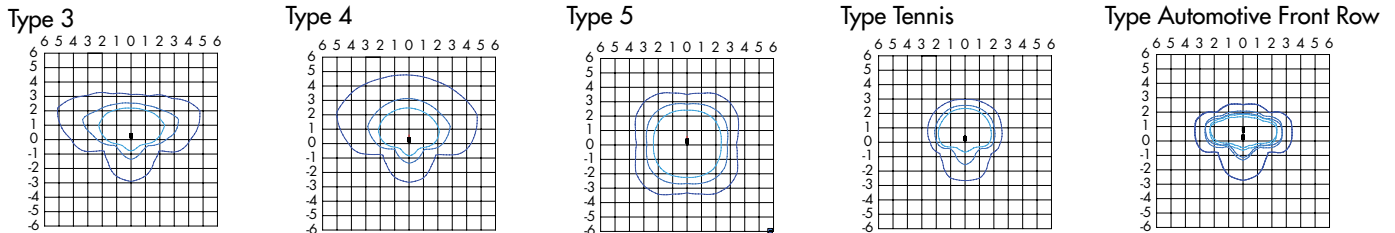

## Accessories (Order as separate line items)

### Mounting Accessories

- EN14628 - Round pole straight arm - bronze
- EN27395 - Square pole mount - bronze
- EN36717 - Adjustable slipfitter - bronze
- EN38159 - Mast arm (Horizontal tenon) - bronze

### Wireless Controls Accessories

- WCN-7P-UNV - Synapse<sup>®</sup> Twist lock controller
- WCG-450 - Synapse<sup>®</sup> Gateway

### Photocell Accessories

- PH12415 - 3-pin Twist lock photocell (120-277V)
- PH87145 - 3-pin Twist lock photocell (347V)
- PH81156 - 3-pin Twist lock photocell (480V)
- PH81975 - Replacement shorting cap

### Factory Installed Options

- "-SH" - Backlight Shield (EN68320)
- "-M12" - Wireless BLE Sensor 120-277V (PH43982) + Sensor lens (PH47512)
- "-M34" - Wireless Sensor 347-480V (PH52149) + Sensor lens (PH47512)

### Miscellaneous Accessories

- SP12714 - 120-277V surge protector
- SP12826 - 347-480V surge protector
- PH46224 - Wireless program tool for M34 options



# LED TRADITIONAL STYLE WALLPACK

## Select-Pro® Wallpack

Order Code	3000K		4000K		5000K		CRI	Lumen Maint. @50,000 hours <sup>†</sup>	Calc. L70@25°C Amb.(hrs) <sup>†</sup>	Fixt. Color	DLC Qualified
	Wattage	Lumen Output LPW	Lumen Output LPW	Lumen Output LPW							
WP16318	80	12032 150	12770 160	12245 153	≥80	90%	174,000	Bronze	Premium		
	65	9596 148	10185 157	9766 150							
	50	7382 148	7834 157	7512 150							
	35	5167 148	5484 157	5259 150							
	20	2953 148	3134 157	3005 150							
WP53512	150	21514 143	23223 155	21438 143	≥80	90%	174,000	Bronze	Premium		
	130	17940 138	19370 149	17810 137							
	110	15180 138	16390 149	15070 137							
	90	12420 138	13410 149	12330 137							
	70	9660 138	10430 149	9590 137							

NOTE: † Lumen maintenance data is based on LED testing per IESNA LM-80 and projected per IESNA TM-21

### Benefits and Features

- Electrical: 120-277V, 50/60Hz
- 0-10VDC continuous dimming
- Field-adjustable CCT & wattage
- 3 CCT settings: 3000K/4000K/5000K
- 5 wattage settings; 5 different light levels
- UL Listed
- IP65 Rated - suitable for wet locations
- Integrated photocell included
- Glass Lens



CCT Selectable Switch



Wattage Selectable Switch



### Photometrics

20W-80W at 15ft Height

70W-150W at 15ft Height

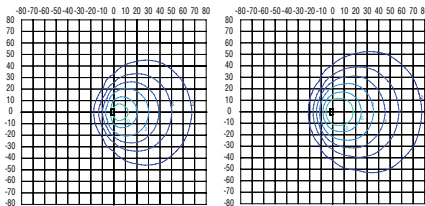

### Dimensions

20W-80W: Weight: 7.7 lbs (3.49 kg)

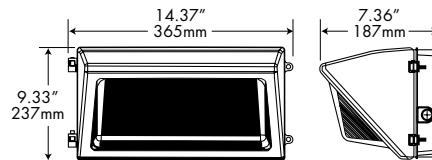

70W-150W: Weight: 11.5 lbs (5.22 kg)

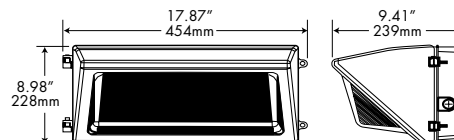

### Accessories (Order as separate line items)

- ☐ SP12714 - 120-277V Surge protector



# LED FLOOD

## Select-Pro® Flood

Order Code	3000K			4000K			5000K			CRI	Lumen Maint. @50,000 hours†	Calc. L70@25°C Amb.(hrs)†	Fixt. Color	DLC Qualified
	Wattage	Lumen Output	LPW	Lumen Output	LPW	Lumen Output	LPW							
FL58601	50	6312	126	7148	143	6576	132	≥80	88%	131,000	Bronze	Premium		
	45	5797	129	6564	146	6039	134							
	40	5153	129	5835	146	5368	134							
	35	4380	125	5153	147	4563	130							
FL70326	90	11320	126	12328	137	11920	132	≥80	88%	131,000	Bronze	Premium		
	80	10188	127	11095	139	10728	134							
	70	9056	129	9862	141	9536	136							
	65	7924	122	8629	133	8344	128							

NOTE: † Lumen maintenance data is based on LED testing per IESNA LM-80 and projected per IESNA TM-21

### Benefits and Features

- Electrical: 120-277V, 50/60Hz
- 0-10VDC continuous dimming
- 3 CCT settings: 3000K/4000K/5000K
- 4 wattage settings; 4 different light levels
- Supplied with U-bracket
- Photocell included - no external photocell required
- Long life and low maintenance
- IP65 Rated - suitable for wet locations



CCT and Wattage Selectable Switches



### Dimensions

35W-50W: Weight: 4.4 lbs (2.0 kg)

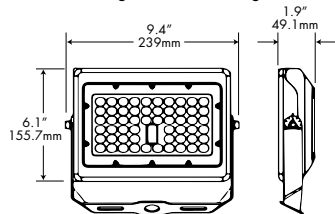

65W-90W: Weight: 6.8 lbs (3.1 kg)

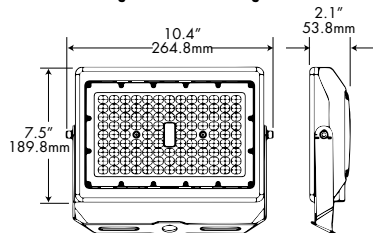

### Accessories (Order as separate line items)

#### Accessories for 35W-50W

- AC14440 - Adjustable knuckle mount
- AC14435 - Adjustable slipfitter mount



AC14440



AC14435

#### Accessories for 65W-90W

- AC14450 - Adjustable knuckle mount
- AC14445 - Adjustable slipfitter mount
- SP12714 - 120-277V Surge protector



AC14450



AC14445



SP12714



# LED FLOOD

## VFlood

120-277V

Order Code	Wattage	Lumen Output	Color Temp.	CRI	Lumen Maint. @50,000 hours <sup>†</sup>	Calc. L70@25°C Amb.(hrs) <sup>†</sup>	Fixt. EPA	Fixt. Color	Replace HID Wattage	DLC Qualified	DLC Model Number
FL21258	212	23640	4000K	≥80	93%	258,000	0.51	Bronze	1000W	-	-
FL00502	212	25343	5000K	≥80	93%	258,000	0.51	Bronze	1000W	-	-

NOTE: † Lumen maintenance data is based on LED testing per IESNA LM-80 and projected per IESNA TM-21 Available in 3000K and 3500K, check for lead time.

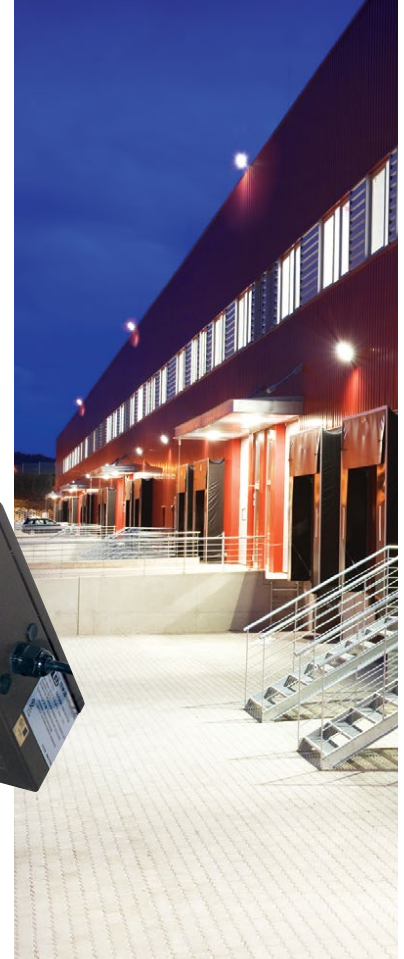

### Benefits and Features

- Electrical: 120-277V or 277-480V, 50/60Hz
- 0-10VDC dimming standard
- Rugged die cast housing with a durable powder coat finish
- Tempered glass lens
- Twist lock photocell receptacle and shorting cap included with the fixture
- 10kA surge protection
- cULus Listed; Rated for wet locations
- IP65 Rated – Suitable for wet locations

### Photometrics

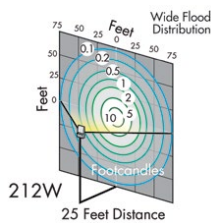

### Wattage

212W

### B-U-G Rating

B4-U2-G2

### Dimensions

212W: Weight: 21.8 lbs (9.88 kg)

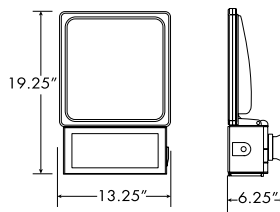

### Accessories (Order as separate line items)

- FL99436 - U-bracket for 212W, bronze
- FL22402 - 6" square pole straight arm, bronze
- FL26815 - 6" round pole straight arm (4" min.), bronze
- FL25107 - Adjustable slipfitter (2-3/8" tenon), bronze
- PH12415 - 3-pin twist lock photocell (120-277V)
- PH87145 - 3-pin twist lock photocell (347V)
- PH81156 - 3-pin twist lock photocell (480V)
- PH81975 - Twist lock shorting cap
- SP12714 - 120-277V surge protector
- SP19245 - 347-480V surge protector
- WCN-7P-UNV - Synapse® twist lock controller
- WCG-450 - Synapse® Gateway





# CANOPY LIGHTING

## Select-Pro® Canopy

Order Code	Wattage	3000K		4000K		5000K		CRI	Lumen Maint. @50,000 hours†	Calc. L70@25°C Amb.(hrs)†	DLC Qualified
		Lumen Output	LPW	Lumen Output	LPW	Lumen Output	LPW				
CP12789	40	5000	125	5450	136	5400	135	≥80	88%	319,000	Premium
	30	3750	125	4100	136	4050	135				
	20	2500	125	2750	136	2700	135				
CP41916	75	9250	123	10000	133	9950	133	≥80	88%	293,000	Premium
	60	7400	123	8000	133	7950	133				
	40	4950	123	5350	133	5300	133				

† Lumen maintenance data is based on LED testing per IESNA LM-80 and projected per IESNA TM-21



**INTEGRATED EMERGENCY BATTERY BACKUP**



## Benefits and Features

- Color Temperature (CCT) and Wattage Selectable
- Integrated photocell standard
- 110 degree wide distribution lens
- Surface or Pendant mount options
- Factory installed Integrated Emergency Battery Backup options available
- Integrated microwave motion sensor option
- Tamper resistant screw option available
- IP65 Rated – Suitable for wet locations

## Dimensions

20-40W Select-Pro Canopy  
Weight: 3.85 lbs (1.75 kg)

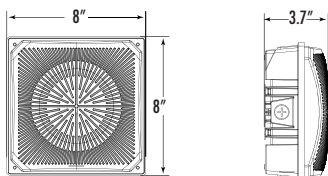

40-75W Select-Pro Canopy  
Weight: 6.12 lbs (2.78 kg)

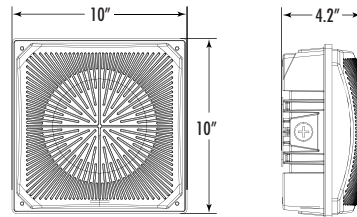

## Accessories (Order as separate line items)

### Mounting Accessories

- PH12568 - 12VDC Microwave Sensor, Internal mount
- AC13752 - Wireless Sensor Programming Tool
- SP12714 - Surge protector (120-277V)
- LN19342 - 160 Degree lens for 40W
- LN19346 - Tamper-resistant screws



Integrated Battery Backup

Add "-EM" to order code for factory installed battery backup  
Add "-S7" to order code for factory installed 12VDC Microwave Sensor (PH12568)  
Add "-TRS" to order code for factory installed tamper resistant screws (AC31925)

## Photometrics

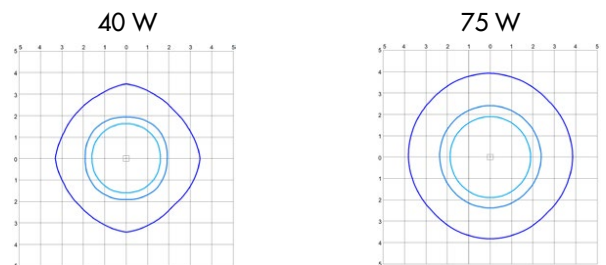

10ft mounting height. Divisions are multiples of mounting height.



# LED RECESSED CANOPY LIGHTING

## Low Glare Cascade

Order Code	Wattage	Lumen Output	Color Temp	CRI	Lumen Maint. @50,000 hours <sup>†</sup>	Calc. L70@25°C Amb.(hrs) <sup>†</sup>	Fixture Color	DLC Qualified	Replaces Existing HID Wattage	DLC Model Number
CP12609	21W	3300	4000K	≥70	98%	>190,000	White	Premium	Up to 100W	CPC-03N-25LNA-WHAC
CP14183	21W	3300	5000K	≥70	98%	>190,000	White	Premium	Up to 100W	CPC-03C-25LNA-WHAC
CP13382	27W	4100	4000K	≥70	98%	>190,000	White	Premium	Up to 150W	CPC-03N-45LNA-WHAC
CP17031	27W	4100	5000K	≥70	98%	>190,000	White	Premium	Up to 150W	CPC-03C-45LNA-WHAC
CP32916	44W	6600	4000K	≥70	98%	>190,000	White	Premium	Up to 250W	CPC-03N-60LNA-WHAC
CP33187	44W	6600	5000K	≥70	98%	>190,000	White	Premium	Up to 250W	CPC-03C-60LNA-WHAC
CP46127	53W	8200	4000K	≥70	98%	>190,000	White	Premium	Up to 320W	CPC-03N-80LNA-WHAC
CP49016	53W	8200	5000K	≥70	98%	>190,000	White	Premium	Up to 320W	CPC-03C-80LNA-WHAC

† Lumen maintenance data is based on LED testing per IESNA LM-80 and projected per IESNA TM-21

## Benefits and Features

- Heavy-duty aluminum housing with a durable powder coat finish
- High-performance, UV stabilized acrylic optics
- Optical chamber is sealed and gasketed
- Low glare lens
- Operating temperature range of -40° C to 40° C
- 10kA surge protection
- IP66 Rated – Suitable for wet locations
- Design Lights Consortium® (DLC) qualified
- 5 year warranty
- Up to 76% Energy Savings
- Universal 120-277V 50/60 Hz input
- 0-10VDC dimming standard to maximize energy savings



## Photometrics

Mounted at 10ft

Grid is multiples of Mounting Height

21 W

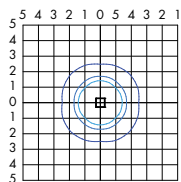

44 W

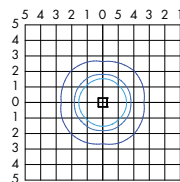

27 W

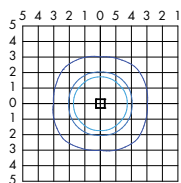

53 W

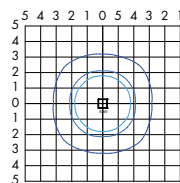

## Dimensions

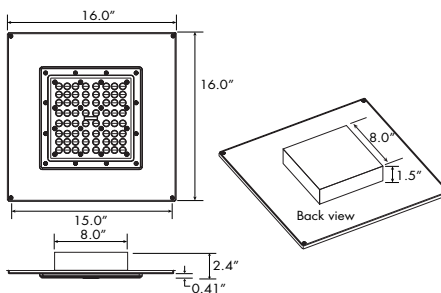

## Accessories (Order as separate line items)

- AC25420 - 3/8" 3-Wire 14/3 6ft. Flex Whip
- AC25425 - 3/8" 5-Wire 18/3, 18/2 6ft Flex Whip
- SP12714 - Surge protector (120-277V)

Add suffix *“-WP”* to order code for a factory installed fixture with a 6ft whip (Part #AC25420)



**IP66**



# GAS STATION CANOPY LIGHTING

## Gas Station Canopy

Order Code	Wattage	Lumen Output	Color Temp	CRI	Lumen Maint. @50,000 hours†	Calc. L70@25°C Amb.(hrs)†	Fixture Color	DLC Qualified	Replaces Existing HID Wattage	DLC Model Number
CP20297	150W	21057	5000K	≥80	90%	174,000	White	Premium	400W	CPT-150SAM-WH50

† Lumen maintenance data is based on LED testing per IESNA LM-80 and projected per IESNA TM-21

### Benefits and Features

- Constructed from heavy-duty aluminum
- Designed for surface mounting
- Low profile, lightweight design
- Vandal resistant polycarbonate lens
- Operating temperature range of -40° C to 40° C
- DesignLights Consortium® (DLC) Premium qualified
- 5 year warranty
- IP65 rated for wet locations
- Driver housing hidden in ceiling

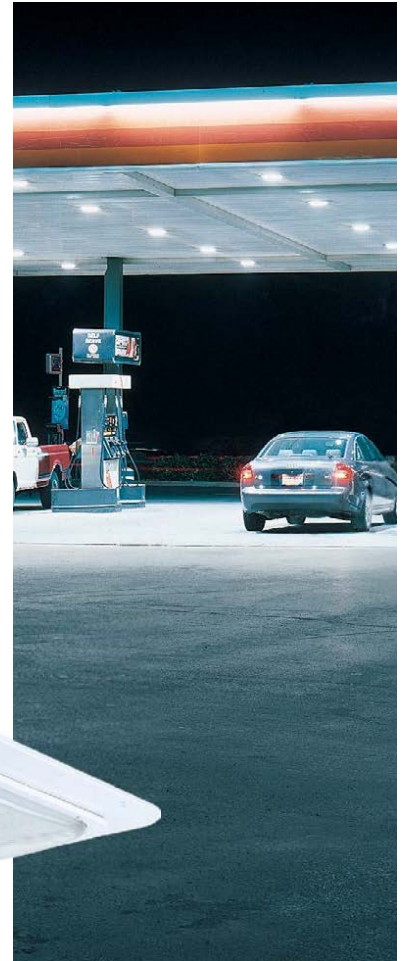

### Photometrics

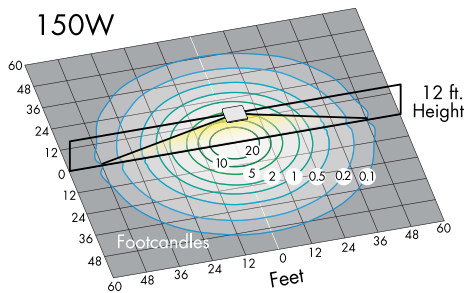

### Dimensions

Weight: 17 lbs (7.7 kg)

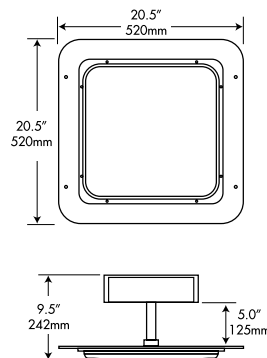

### Accessories (Order as separate line items)

☐ SP12714 - Surge protector (120-277V)



# GARAGE LIGHTS

## Select-Pro® Garage Lights

Order Code	Wattage	3000K		4000K		5000K		Lumen Maint. @50,000 hrs <sup>†</sup>	Calc. L70@25°C Amb.(hrs) <sup>†</sup>	DLC Qualified	
		Lumen Output	LPW	Lumen Output	LPW	Lumen Output	LPW				
CP40160	40	5000	125	5400	135	5450	136.25	≥80	94%	319,000	Premium
	30	3750	125	4050	135	4100	136.66				
	20	2500	125	2700	135	2750	137.50				
CP75160	75	9025	120	9650	128.66	9625	128.33	≥80	94%	293,000	Premium
	60	7200	120	7700	128.33	7700	128.33				
	40	5000	125	5150	128.75	5150	128.75				

<sup>†</sup> Lumen maintenance data is based on LED testing per IESNA LM-80 and projected per IESNA TM-21

### Benefits and Features

- Color Temperature (CCT) and Wattage Selectable
- Integrated photocell standard
- 160 degree wide distribution lens
- Surface or Pendant mount options
- Factory installed Integrated Emergency Battery Backup options available
- Integrated microwave motion sensor option
- Tamper resistant screw option available
- IP65 Rated – Suitable for wet locations

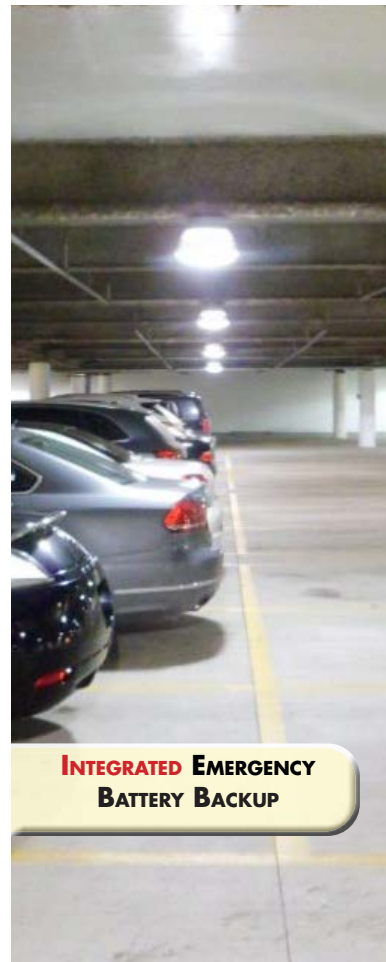

### Dimensions

20-40W Select-Pro Garage Light  
Weight: 3.85 lbs (1.75 kg)

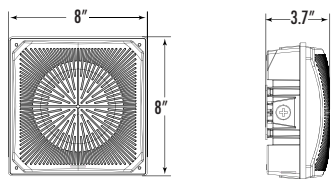

40-75W Select-Pro Garage Light  
Weight: 6.12 lbs (2.78 kg)

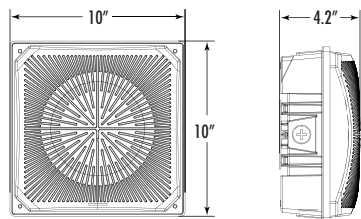

### Photometrics

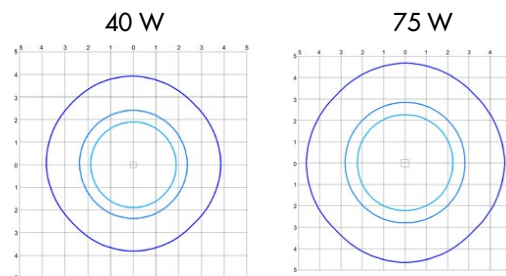

10ft mounting height. Divisions are multiples of mounting height.

### Accessories (Order as separate line items)

#### Mounting Accessories

- PH12568 - 12VDC Microwave Sensor, Internal mount
- AC13752 - Wireless Sensor Programming Tool
- SP12714 - Surge protector (120-277V)
- LN19346 - Tamper-resistant screws

Add "-EM" to order code for factory installed battery backup  
Add "-S7" to order code for factory installed 12VDC Microwave Sensor (PH12568)  
Add "-TRS" to order code for factory installed tamper resistant screws (AC13925)



Integrated Battery Backup



# TENNIS AND PICKLEBALL LIGHTING SOLUTIONS



480W CrossCourt



# CROSSCOURT TENNIS AND PICKLEBALL LIGHTING

## Low Watt CrossCourt Ordering & Model Number Information

Choose nomenclature that suits application. Example: **ENV-200CTT-ABZ-M12**

ENV - 200		C	TT - A	BZ - SH	M12		
Fixture Type	Wattage	Color Temp.	Optics	Voltage	Fixture Finish	Shield	Options
ENV - Venture's LED Tennis Fixture	<input type="checkbox"/> 200-200W	<input type="checkbox"/> W-3000K <input type="checkbox"/> B-3500K <input type="checkbox"/> N-4000K <input type="checkbox"/> C-5000K	<input type="checkbox"/> TT-Tennis	<input type="checkbox"/> A-120-277V <input type="checkbox"/> B-347-480V	<input type="checkbox"/> BZ-Bronze	"Blank" - No backlight shield <input type="checkbox"/> SH-Back light Shield	"Blank" - No backlight shield <input type="checkbox"/> M12-120-277V motion sensor <input type="checkbox"/> M34-347-480V motion sensor

Notes: Other fixture finish colors available, contact for details

## Low Watt CrossCourt Performance Data

Wattage	Lumen Output	Color Temp	CRI	Lumen Maint. @50,000 hours <sup>†</sup>	Calc. L70@25°C Amb.(hrs) <sup>†</sup>	Fixture EPA	Color	Amperage Draw (A) 120V 277V 347V 480V	Replaces Existing HID Wattage
200W	24000	4000K	>70	99%	>500,000	0.70	Bronze	1.70 0.73 0.58 0.43	250W V, 400W H
200W	24150	5000K	>70	99%	>500,000	0.70	Bronze	1.70 0.73 0.58 0.43	250W V, 400W H

NOTE: † Lumen maintenance data is based on LED testing per IESNA LM-80 and projected per IESNA TM-21

## Dimensions

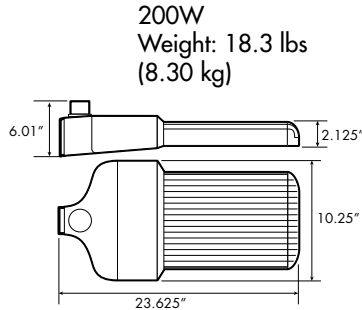

## Accessories (Order as separate line items)

### Mounting Accessories

- EN14178 - Round pole straight arm - bronze
- EN26814 - Square pole mount - bronze
- EN35512 - Adjustable slipfitter - bronze
- EN38419 - Mast arm (Horizontal tenon) - bronze
- EN47832 - Wall mount - bronze

### Wireless Controls Accessories

- WCN-7P-UNV - Synapse® Twist lock controller
- WCG-450 - Synapse® Gateway

### Factory Installed Options

- "-SH" - Backlight Shield (EN67410)
- "-M12" - Wireless BLE Sensor 120-277V (PH43982)  
+ Sensor Lens (PH47512)
- "-M34" - Wireless Sensor 347-480V (PH52149)  
+ Sensor Lens (PH47512)

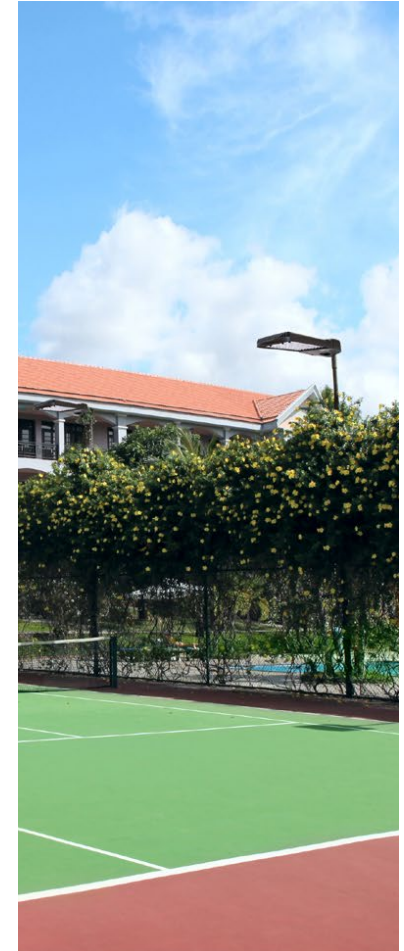

## Benefits and Features

- Rugged die cast housing with a durable powder coat finish
- Vandal resistant polycarbonate lens
- Optical chamber is sealed and gasketed
- Factory installed motion sensor available
- Operating temperature range of -40° C to 40° C
- 10kA surge protection
- UL Listed for wet locations
- Universal 120-277V 50/60 Hz input or 347-480V input
- Each fixture will be supplied with a 7-pin receptacle and a shorting cap
- Reduced glare
- Superior spill light control
- Longer product life - Reduced maintenance costs
- Ability to illuminate individual courts when coupled with controls
- Lower visual impact on the surrounding environment
- 1-10VDC dimming standard to maximize energy savings
- IP65 Rated - Suitable for wet locations



# TENNIS AND PICKLEBALL LIGHTING

## High Watt CrossCourt Ordering & Model Number Information

Choose nomenclature that suits application. Example: **ENV2-300A-7CTT-BZP7SH**

ENV2 - 300	A	7	C	TT	- BZ	P7	SH		
Series	Wattage	Voltage	CRI	CCT	Distribution	Finish	Receptacle	Accessory 1	Accessory 2
ENV2 - Environ Area Light	<input type="checkbox"/> 300-300W <input type="checkbox"/> 480-480W	<input type="checkbox"/> A-120-277V <input type="checkbox"/> B-347-480V	<input type="checkbox"/> 7-70	<input type="checkbox"/> C-5000K <input type="checkbox"/> N-4000K' <input type="checkbox"/> W-3000K'	<input type="checkbox"/> TT-Type Tennis	<input type="checkbox"/> BR-Bronze <input type="checkbox"/> BK-Black' <input type="checkbox"/> GR-Gray' <input type="checkbox"/> WH-White'	<input type="checkbox"/> P7-7Pin (Standard)	"Blank"-None <input type="checkbox"/> M1-120-277V Motion Sensor <input type="checkbox"/> M3-120-277V Motion Sensor	"Blank"-No backlight shield <input type="checkbox"/> SH-Backlight Shield

Notes: Limited Stocked Quantities Available

## High Watt CrossCourt Performance Data

Wattage	Distribution Type	BUG	3000K Lumens	4000K Lumens	5000K Lumens	CRI	Lumen Maint. @50,000 hours <sup>†</sup>	Calc. L70@25°C Amb.(hrs) <sup>†</sup>	DLC Qualified	Replaces Existing HID Wattages
300W	Type T	B3-U3-G3	40,763	42,699	45,976	≥70	88%	142,000	Premium	Up to 1000W
480W	Type T	B4-U3-G4	64,537	67,603	72,792	≥70	88%	142,000	Premium	Up to 1000W

NOTE: Mounting accessories are ordered separately  
† Lumen maintenance data is based on LED testing per IESNA LM-80 and projected per IESNA TM-21

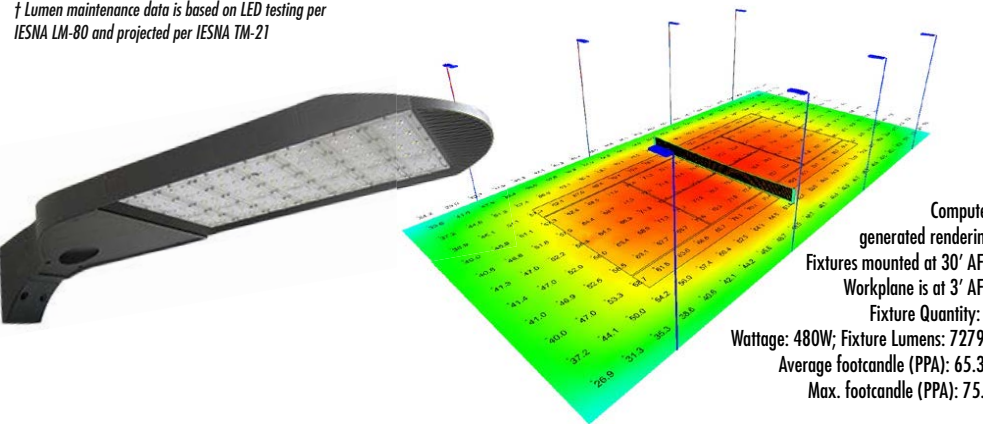

### Photometrics

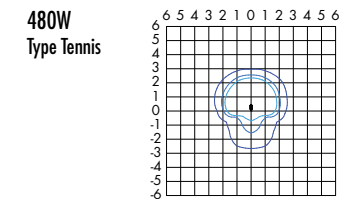

NOTE: 30' mounting height.  
Divisions are multiples of mounting height.

### Dimensions

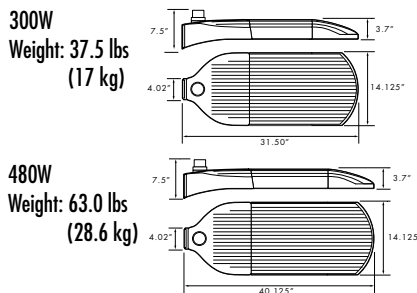

### Accessories (Order as separate line items)

#### Mounting Accessories

- EN14628 - Round pole straight arm - bronze
- EN27395 - Square pole mount - bronze
- EN36717 - Adjustable slipfitter - bronze
- EN38159 - Mast arm (Horizontal tenon) - bronze

#### Wireless Controls Accessories

- WCN-7P-UNV - Synapse® Twist lock controller
- WCG-450 - Synapse® Gateway

#### Photocell Accessories

- PH12415 - 3-pin Twist lock photocell (120-277V)
- PH81156 - 3-pin Twist lock photocell (480V)
- PH87145 - 3-pin Twist lock photocell (347V)
- PH81975 - Replacement shorting cap

#### Miscellaneous Accessories

- SP12714 - 120-277V surge protector
- SP12826 - 347-480V surge protector
- PH46224 - Wireless program tool for M3 sensor option

#### Factory Installed Options

- "-SH" - Backlight Shield (EN68320)
- "-M1" - Wireless BLE Sensor 120-277V (PH43982) + Sensor lens (PH47512)
- "-M3" - Wireless Sensor 347-480V (PH52149) + Sensor lens (PH47512)



# LED RETROFIT LAMPS



54W LED Retrofit lamp





# LED RETROFIT LAMPS

## Medium Base Lamps

Order Code	Wattage	Base Type	Lumen Output	Color Temp	CRI	Lumen per Watt	Rated Life (hrs)	Replaced Up To	UL 1993C Certified	UL 1598C Certified
LP17892	8W	E26	1100	3000K	≥80	140	50,000	50W	Yes	-
LP18512	10W	E26	1200	3000K	≥80	120	50,000	50W	Yes	-
LP23242	12W	E26	1700	4000K	≥80	140	50,000	50W	Yes	Yes
LP26748*	14W	E26	1680	3000K	≥80	120	50,000	70W	Yes	-
LP31517*	18W	E26	2160	3000K	≥80	120	50,000	100W	Yes	-
LP21358	18W	E26	2600	4000K	≥80	140	50,000	100W	Yes	Yes
LP36178*	22W	E26	2640	3000K	≥80	120	50,000	175W	Yes	-
LP10829	24W	E26	3350	4000K	≥80	140	50,000	175W	Yes	Yes
LP41072	27W	E26	3850	4000K	≥80	140	50,000	175W	Yes	Yes
LP43918	27W	E26	3900	5000K	≥80	142	50,000	175W	Yes	Yes
LP38326	36W	E26	5075	4000K	≥80	140	50,000	175W	Yes	Yes
LP15961	54W	E26	7600	4000K	≥80	140	50,000	250W	Yes	Yes
LP21921	54W	E26	7700	5000K	≥80	142	50,000	250W	Yes	Yes

## Mogul Base Lamps

Order Code	Wattage	Base Type	Lumen Output	Color Temp	CRI	Lumen per Watt	Rated Life (hrs)	Replaces Up To	UL 1993C Certified	UL 1598C Certified
LP72163	27W	EX39	3850	4000K	≥80	140	50,000	175W	Yes	Yes
LP75409	27W	EX39	3900	5000K	≥80	142	50,000	175W	Yes	Yes
LP78106*	36W	EX39	5000	4000K	≥80	140	50,000	175W	Yes	Yes
LP39831	36W	EX39	5150	5000K	≥80	142	50,000	175W	Yes	Yes
LP94209*	45W	EX39	6300	4000K	≥80	140	50,000	175W	Yes	Yes
LP26126*	45W	E39	5400	5000K	≥80	120	50,000	175W	Yes	Yes
LP18193	54W	EX39	7600	4000K	≥80	140	50,000	250W	Yes	Yes
LP18739	54W	EX39	7700	5000K	≥80	142	50,000	250W	Yes	Yes
LP20816	100W	EX39	14,000	4000K	≥80	140	50,000	400W	Yes	Yes
LP31437	100W	EX39	14,200	5000K	≥80	142	50,000	400W	Yes	Yes

Note: \* While supplies last

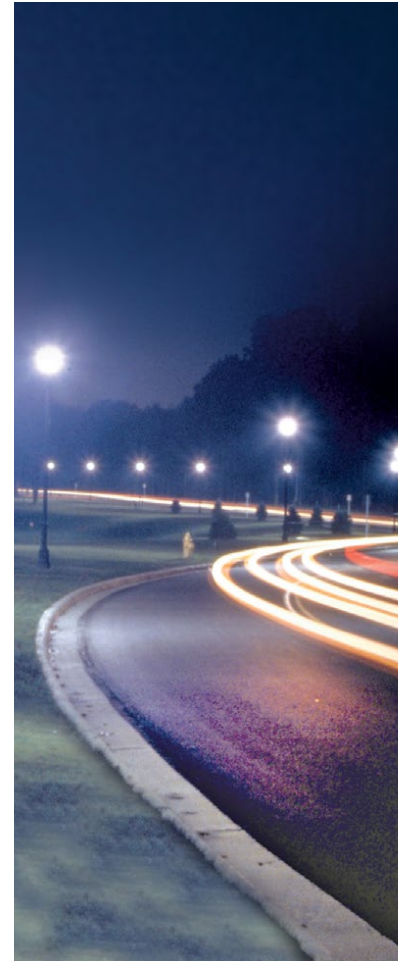

## Dimensions

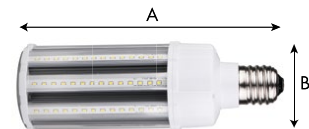

## Benefits and Features

- Universal Burn Position - Omnidirectional (base-up/base-down/horizontal operation)
- Easy installation, medium and mogul bases available
- Integrated driver with PF > 90% and THD <20%
- 5 year warranty

## Wiring

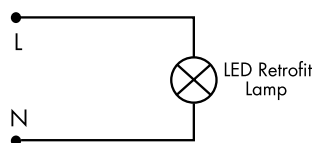

Easy to install - bypass ballast and provide voltage directly to lamp

## Accessories (Order as separate line items)

- SP12714 - Surge protector (120-277V)



Watts	Base	A	B
12W	E26	4.92" (125mm)	2.36" (60mm)
18W	E26	5.71" (145mm)	2.36" (60mm)
24W	E26	7.52" (191mm)	2.36" (60mm)
27W	E26	6.69" (170mm)	2.36" (60mm)
27W	EX39	7.32" (186mm)	2.36" (60mm)
36W	E26	7.56" (192mm)	3.35" (85mm)
36W	EX39	8.43" (214mm)	3.35" (85mm)
45W	EX39	9.96" (253mm)	3.35" (85mm)
54W	E26	9.10" (231mm)	3.35" (85mm)
54W	EX39	9.96" (253mm)	3.35" (85mm)
100W	EX39	10.43" (265mm)	5.12" (130mm)



# SPECIALTY LED RETROFIT LAMPS

## Lowbay - Retrofit Lamp

Order Code	Wattage	Base Type	Lumen Output	Color Temp	CRI	Rated Life (hrs)	Power Factor	THD
LP91312	40W	E26	4800	4000K	≥80	50,000	>0.90	<20%
LP27198	40W	E39	4800	4000K	≥80	50,000	>0.90	<20%

### Benefits and Features

- Energy saving replacement for 175W MH or HPS
- Up to 5 times longer life and 80% energy savings compared to HID
- 5 year warranty
- Easy installation
- Reduced maintenance costs
- Perfect for applications such as lowbays, canopies, garages, and general illumination



### Photometrics

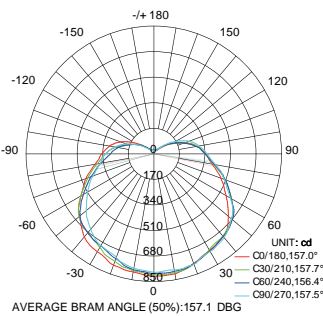

### Dimensions

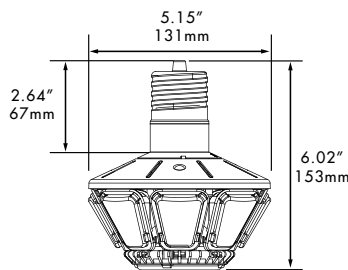

Dimensions the same for both EX39 and E26 base versions

### Wiring

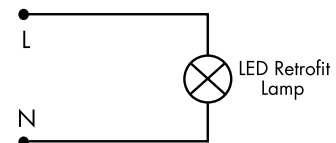

Easy to install - bypass ballast and provide voltage directly to lamp

### Accessories (Order as separate line items)

- ☐ SP12714 - Surge protector (120-277V)



SP12714



Certified to UL 1993/  
CSA C22.2 No. 1993



Certified to UL 1598C/  
CSA C22.2 No. 250.1



# WIRELESS CONTROLS & SENSORS

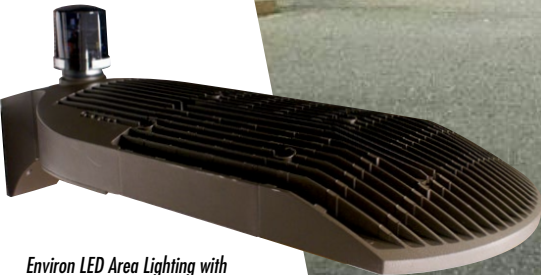

*Environ LED Area Lighting with Synapse® Twist Lock Controller*





SimplySNAP is a wireless lighting control solution that enables considerable energy savings and lowers operating costs by automating, customizing, and controlling the behavior of lights.

Built for easy installation and use, SimplySNAP doesn't require Internet access and can scale to hundreds of lights, all controlled by a single site controller. SimplySNAP is powered by an encrypted, self-forming, self-healing, 802.15.4 SNAP mesh network and provides a reliable and secure foundation for your lighting network.

SimplySNAP makes commissioning easy with four provisioning options. In addition to manual entry and CSV upload, the Synapse mobile commissioning application, and auto-discovery of unconfigured lights makes commissioning child's play.

Day-to-day operation is just as easy thanks to a browser-based user interface that's accessed through a mobile-friendly Wi-Fi interface. Easy access from a laptop or tablet means your system can be controlled or reconfigured whenever needed. With the optional SimplySNAP Remote Access service, your lighting network can also be managed remotely from anywhere you have an Internet connection.

The system stores power data, alarms, and critical events locally for maintenance and troubleshooting, and provides California Title 24 compliant daily schedules. Occupancy and ambient light sensor integration allows full lighting network customization under a variety of situations.

With programmable schedules and easy setup, SimplySNAP is the perfect solution for lighting control; you just configure it and it runs.

### Benefits

- No Internet Required - Site based control
- Web browser based commissioning and control
- Control Individual Fixtures, as well as groups of fixtures based on automated schedules or sensor events
- Secure connection to Site Controller via Wi-Fi and/or LAN
- Automatic software upgrades via encrypted over-the-air communications or USB flash drive
- Graphical representation of power consumption
- Multiple Zones, Behaviors, and Events
- Data and events stored on local Site Controller
- Upgradable to all future SimplySNAP releases

### Common Applications

- Parking Lots
- Parking Garages / Decks
- Roadway/Pathway Lighting
- Sports Facilities
- Colleges / Schools

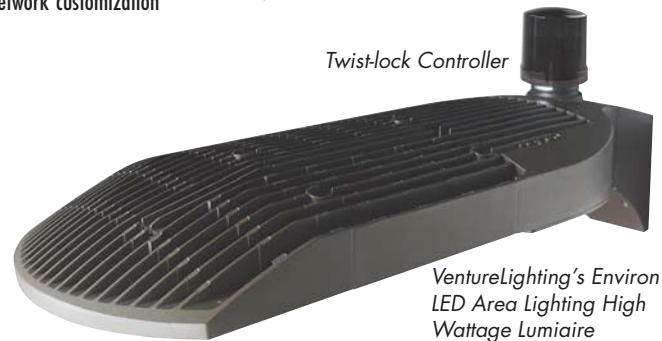

### Components

Product Type	Part Number	Product Description
Gateway	WCG-450	SimplySNAP Site Controller, WiFi, Verizon LTE, Metal Enclosure
	WCG-450-CBS-5B	Central Base Station - Nema Enclosure, 5-Button Switch, Includes WCG-450
	WCG-BMS-GW	BMS Gateway for SimplySNAP Site Controller, BACnet, Modbus Compatible
Individual Fixture Controllers	WCN-7P-UNV	7-Pin Twistlock Controller, 6kV Surge and Utility Grade Power Monitoring, Integral Photocell, Digital and Analog Sensor Input, 120-480V
Accessories	5B-SW	Switch, USB, 5-Button, Stand Alone
	ANT-8-REM	Remote Mount SNAP Antenna, Outdoor, Staright, 8.0 dBi Gain
	ANT-2-INT	Indoor Articulating Antenna 2.0 dBi Gain
	ANT-1.5-EXT	Outdoor Straight Antenna 1.5 dBi Gain



# CONTROLS - LUTRON

To compliment Venture LED indoor lighting fixtures, Venture Lighting offers a range of Lutron wireless sensors & controllers to maximize energy savings in new & existing commercial buildings. Venture Lighting LED fixture that are compatible with Lutron Wireless Lighting Controls, will have this symbol on the page. To complete most lighting solutions Venture Lighting is happy to offer the following Lutron controls. Contact Venture Lighting or your Venture Lighting Representative for more information.



## Product Colors *Select from these color below*



## Area Dimming and Sensing

### Private office

Dim a group of lights together while also providing manual control. Save additional energy with daylight harvesting.



## Simple Switching

### Restroom

Occupancy sensors control all lights together by switching lights on and off in response to room occupancy.



## Individual fixture dimming and sensing

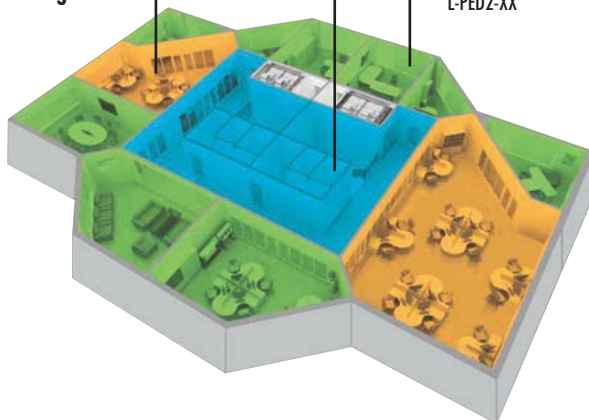

## Lutron Controls *PowPack - Wireless (RF) Controllers*

Part Number	Description
RMJS-16R-DV-B	Control lighting zone in the space, 16 amp, On/ Off
RMJS-5R-DV-B	Control lighting zone in the space ,5 amp, On/ Off
RMJS-8T-DV-B	Control 0-10 V lighting zone in the space, 8 amp, On/ Off, 0-10v dimming
RMJS-CCO1-24-B	Control additional contact closure output, VAV terminal unit
RMJS-20R-DV-B	Control each 20 A receptacle circuit you want to control, 20A receptacle circuit
FCJS-010	Control each fixture in the space, 1 amp per fixture, 0-10v dimming
FCJS-010-BULK8	Control each fixture in the space, 1 amp per fixture, 0-10v dimmingBlack

## Lutron Sensors *Radio Powr Savr - Occupancy, Vacancy & Daylight Sensors*

Part Number	Description
LRF2-OCR2B-P-WH	Ceiling-mount, 360° field-of-view, occupancy/vacancy sensor
LRF2-OWL-B-P-WH	Wall-mount, 180° field-of-view, occupancy/vacancy sensor
LRF2-VWL-B-P-WH	Wall-mount, 180° field-of-view, sensor vacancy only
LRF2-OKLB-P-WH	Corner-mount, 90° field-of-view, occupancy/vacancy sensor
LRF2-VKLB-P-WH	Corner-mount, 90° field-of-view, vacancy only sensor
LRF2-VHLB-P-WH	Hallway, vacancy only sensor
LRF2-DCRB-WH	Ceiling-mount daylight sensor
DFCSJ-OEM-RF	DALI/EcoSystem In-Fixture RF Module with Integral Occ/Daylight Sensor
DFCSJ-OEM-OCC	DALI/EcoSystem In-Fixture RF Module Only

## Lutron Switches *Maestro - Wireless Wall Mounted Switches & Dimmers*

Part Number	Description
MRF2S-6ANS-XX	Vive Maestro Wireless Switch 6 AMP (Neutral Needed) On/ Off
MRF2S-8S-DV-XX	Maestro Wireless 8 Amp Multi-location Switch On/ Off
MRF2S-8ANS-120-XX	8A lighting, 5.8A fan (1/4HP motor), spec grade, 120V (Neutral Needed) On/ Off
MRF2S-6CL-XX	150W dimmable CFL/LED, 600W incandescent, halogen, 600VA MLV, 120V, no neutral
MRF2S-6ELV-XX	600W ELV, 120V (Electric Low Voltage)

## Lutron Remotes and Accessories *Pico*

Part Number	Description
PJ2-2BRL-GXX-L01	2-button with raise/lower
PJ2-2B-GXX-L01	2-button
PJ2-3BRL-GXX-L01	3-button with raise/lower
PJ2-3B-GXX-L01	3-button
CW-1-XX	Claro 1-gang wall plate
CW-2-XX	Claro 2-gang wall plate
PICO-WBX-ADAPT	wireless remote wall box adapter
L-PED1-XX	wireless remote single pedestal
L-PED2-XX	wireless remote double pedestal



## Photosensors/Shorting Cap

Order Code	Description	Voltage Range	Product Color
PH56903	Button Photocell (120-277V)	120-277V AC	Black
PH12415	Twist lock photocell (120-277V)	105-305V AC	Blue
PH81156	Twist lock photocell (480V)	480V AC	Yellow
PH87145	Twist lock photocell (347V)	347V AC	Black
PH81975	Twist lock shorting cap	120-480V AC	Black

## Dry-Damp Rated Sensors\*

Order Code	Description	Voltage Range	Product Color
PH41623	Dry/Damp Rated Motion/On-Off Only Control Sensor	120-277V AC	White
PH77409	Dry/Damp Rated Motion/Photocell/Dimming Control Sensor	120-277V AC	White
PH48156	Dry/Damp Rated Motion/On-Off Only Control Sensor	277-480V AC	White
PH52321	Dry/Damp Rated Motion/Photocell/Dimming Control Sensor	277-480V AC	White

## Wet Rated Sensors\*

Order Code	Description	Voltage Range	Product Color
PH21458	Wet Rated Motion Only Control Sensor	120-277V AC	White
PH27419	Wet Rated Motion/Photocell/Dimming Control Sensor	120-277V AC	White
PH28534	Wet Rated Motion Only Control Sensor	120-277V AC	Bronze
PH31256	Wet Rated Motion/Photocell/Dimming Control Sensor	120-277V AC	Bronze
PH36512	Wet Rated Motion Only Control Sensor	347-480V AC	White
PH37415	Wet Rated Motion/Photocell/Dimming Control Sensor	347-480V AC	White
PH46145	Wet Rated Motion Only Control Sensor	347-480V AC	Bronze
PH48159	Wet Rated Motion/Photocell/Dimming Control Sensor	347-480V AC	Bronze
PH58143	Wet Rated Motion Only Control Sensor (Long Extension)	347-480V AC	Bronze
PH52171	Wet Rated Motion/Photocell/Dimming Control Sensor (Long Extension)	347-480V AC	Bronze

## Wirelessly Programmed Sensors with lens

Order Code	Description	Voltage Range	Product Color
PH43982	Wireless BLE Programmed Motion/Photocell/Dimming Control Sensor	120-277V AC	White
PH46224	Wireless Sensor Programming Tool for PH52149	N/A	Black
PH47512	Lens for High Mount Applications (Area Lighting)	N/A	White
PH18673	Lens for Low Mount Applications (Parking Garage)	N/A	White
PH52149	Wireless Programmed Motion/Photocell/Dimming Control Sensor	12VDC	White
PH53207	Microwave Sensor, Motion/Photosensor/Dimming, External plug-in	12VDC	White
PH52186	Wireless Sensor Programming Tool for PH53207	N/A	White
PH86347	Microwave Sensor, Motion/Photosensor/Dimming, External plug-in	12VDC	White
AC86350	Wireless Sensor Programming Tool for PH86347	N/A	White
PH12568	12VDC Microwave Sensor, Internal Mount	12VDC	White
AC13752	Wireless Sensor Programming Tool for PH12568	N/A	White

Note: \* With high mount lens. Dry and damp rated sensors viewing angle and Wet rated sensors have the same standard lens

High Mount Lens (Area Lighting)

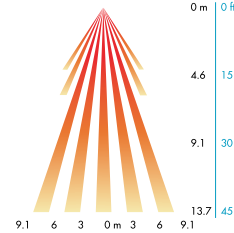
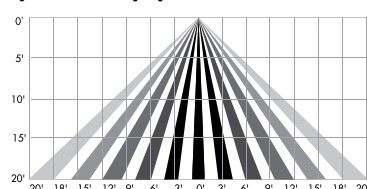

Low Mount Lens (Parking Garage)

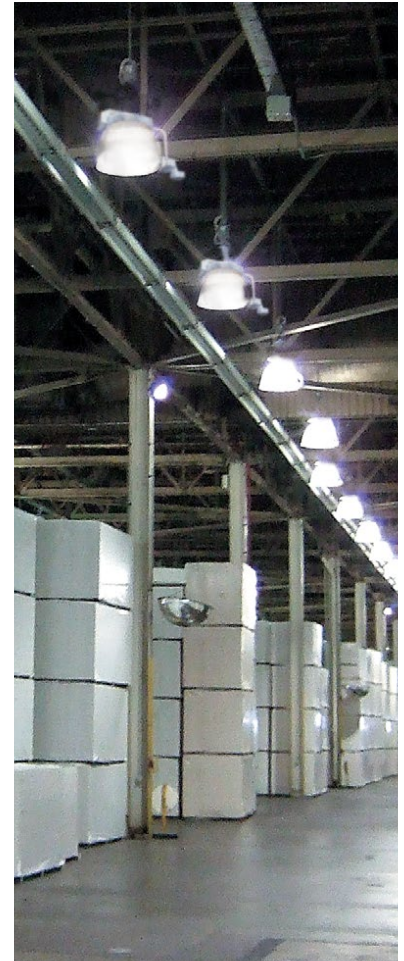
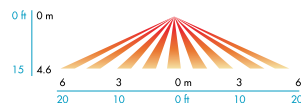
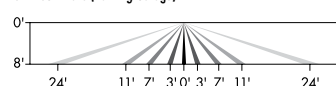

Sensor



Sensor and programming tool



Sensor



PH86347



PH56903



Bluetooth Sensor



PH53207



# HIGH INTENSITY DISCHARGE LIGHTING SOLUTIONS



Super Pulse Start Long Life (SPL) Lamps



# HID METAL HALIDE LAMPS



## Pulse Start and Probe Start Lamps

### Open Rated *Pulse Start* Lamps

Order Code	Watts	Product Description	Bulb	Base	Bulb Finish	Operating Position	CCT	ANSI Code	Case Pack
32100	50	MP 50W/U/PS	EDX17	Medium (E26)	Clear	Universal	4000K	M110/O	12
40389	70	MP 70W/U/PS	EDX17	Medium (E26)	Clear	Universal	4000K	M98/O	12
96770		MP 100W/U/PS/3K	EDX17	Medium (E26)	Clear	Universal	3200K	M90/O	12
96267	100	MP 100W/U/PS	EDX17	Medium (E26)	Clear	Universal	4000K	M90/O	12
22145		MP 100W/C/U/ED28/PS/3K	ED28	Mogul (EX39)	Coated	Universal	3200K	M90/O	12
25813	125	MP 125W/V/ED28/PS	ED28	Mogul (EX39)	Clear	V±15°	4000K	M150/O	12
22455		MP 150W/U/PS/740	EDX17	Medium (E26)	Clear	Universal	4000K	M102/O	12
58963	150	MP 150W/U/ED28/PS/740	ED28	Mogul (EX39)	Clear	Universal	4000K	M102/O	12
31928		MP 175W/C/U/PS/737	ED28	Mogul (EX39)	Coated	Universal	3700K	M152/O	12
18717	175	MP 175W/U/PS/740	ED28	Mogul (EX39)	Clear	Universal	4000K	M152/O	12
44872		MP 200W/C/V/PS/732	ED28	Mogul (EX39)	Coated	V±15°	3200K	M136/O	12
22147	200	MP 200W/V/PS/740	ED28	Mogul (EX39)	Clear	V±15°	4000K	M136/O	12
25029		MP 250W/C/U/PS/737	ED28	Mogul (EX39)	Coated	Universal	3700K	M153/O	12
25028	250	MP 250W/U/PS/740	ED28	Mogul (EX39)	Clear	Universal	4000K	M153/O	12
32029		MP 320W/C/U/ED28/PS/737	ED28	Mogul (EX39)	Coated	Universal	3700K	M154/O	12
32028		MP 320W/U/ED28/PS/740	ED28	Mogul (EX39)	Clear	Universal	4000K	M154/O	12
32039		MP 320W/C/U/ED37/PS/737	ED37	Mogul (EX39)	Coated	Universal	3700K	M154/O	6
32037		MP 320W/U/ED37/PS/740	ED37	Mogul (EX39)	Clear	Universal	4000K	M154/O	6
51208	350	MP 350W/H75/T15/L/PS/740	T15	Mogul (EX39)	Clear	HOR±75°	4000K	M131/O	12
18692		MP 350W/400W/U/ED28/PS/740	ED28	Mogul (EX39)	Clear	Universal	4000K	M131/O, M155/O	12
51352	350/400	MP 350W/400W/C/U/PS/737	ED37	Mogul (EX39)	Coated	Universal	3700K	M131/O, M155/O	6
23589		MP 350W/400W/U/PS/740	ED37	Mogul (EX39)	Clear	Universal	4000K	M131/O, M155/O	6
73189		MP 400W/H75/T15/L/PS/740	T15	Mogul (EX39)	Clear	HOR±75°	4000K	M155/O	12
45541*	400	MP 400W/C/V/PS/737	ED37	Mogul (EX39)	Coated	V±15°	3700K	M155/O	6
65072	450	MP 450W/BU/PS/740	ED37	Mogul (EX39)	Clear	BU±15°	4000K	M144/O	6
37292	575	MP 575W/U/BT37/PS/740	BT37	Mogul (EX39)	Clear	Universal	4000K	M178/O	6
58953	875	MP 875W/BU/BT37/PS/740	BT37	Mogul (EX39)	Clear	BU±15°	4000K	M166/O	6

### Open Rated *Probe Start* Lamps

Order Code	Watts	Product Description	Bulb	Base	Bulb Finish	Operating Position	CCT	ANSI Code	Case Pack
27564	250	MPI 250W/U	ED28	Mogul (EX39)	Clear	Universal	4000K	M58/O	12
28715	400	MPI 400W/U	ED37	Mogul (EX39)	Clear	Universal	4000K	M59/O	6
62948	1000	MPI 1000W/BU	BT56	Mogul (EX39)	Clear	BU±15°	3500K	M47/O	6

NOTE: \* Available while supplies last

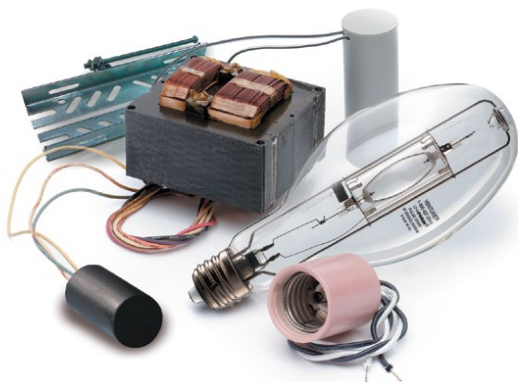



# HID METAL HALIDE LAMPS



## Pulse Start and Probe Start Lamps

### Enclosed Rated *Pulse Start* Lamps

Order Code	Watts	Product Description	Bulb	Base	Bulb Finish	Operating Position	CCT	ANSI Code	Case Pack
52312	50	MH 50W/U/PS	ED17	Medium (E26)	Clear	Universal	4000K	M110/E	12
78138	70	MH 70W/U/PS	ED17	Medium (E26)	Clear	Universal	4000K	M98/E	12
16017		MH 70W/U/ED28/PS	ED28	Mogul (E39)	Clear	Universal	4000K	M98/E	12
27266	100	MH 100W/U/PS	ED17	Medium (E26)	Clear	Universal	4000K	M90/E	12
67868		MH 100W/U/ED28/PS	ED28	Medium (E39)	Clear	Universal	4000K	M90/E	12
99584	150	MH 150W/U/PS/740	ED17	Medium (E26)	Clear	Universal	4000K	M102/E	12
75418		MH 150W/U/ED23.5/PS/740	ED23.5	Mogul (E39)	Clear	Universal	4000K	M102/E	12
13556		MH 150W/U/ED28/PS/740	ED28	Mogul (E39)	Clear	Universal	4000K	M102/E	12
16497		MS 175W/BU/MED/PS/740	ED17	Medium (E26)	Clear	BU±15°	4000K	M152/E	12
29145	175	MH 175W/U/PS/740	ED28	Mogul (E39)	Clear	Universal	4000K	M152/E	12
60811		MS 200W/BU/MED/PS/740	ED17	Medium (E26)	Clear	BU±15°	4000K	M136/E	12
57625	250	MS 250W/H75/T15/PS/740	T15	Mogul (E39)	Clear	HOR±75°	4000K	M153/E	12
37517		MH 250W/U/PS/740	ED28	Mogul (E39)	Clear	Universal	4000K	M153/E	12
57626	320	MS 320W/H75/T15/S/PS/740	T15	Mogul (E39)	Clear	HOR±75°	4000K	M154/E	12
79710		MS 320W/H75/T15/L/PS/740	T15	Mogul (E39)	Clear	HOR±75°	4000K	M154/E	12
12718*		MH 320W/U/ED28/PS/740	ED28	Mogul (E39)	Clear	Universal	4000K	M154/E	12
21785		MH 320W/U/ED37/PS/740	ED37	Mogul (E39)	Clear	Universal	4000K	M154/E	6
60258	350	MS 350W/H75/T15/S/PS/740	T15	Mogul (E39)	Clear	HOR±75°	4000K	M131/E	12
93749		MS 350W/H75/T15/L/PS/740	T15	Mogul (E39)	Clear	HOR±75°	4000K	M131/E	12
50268	350/	MH 350W/400W/U/ED28/PS/740	ED28	Mogul (E39)	Clear	Universal	4000K	M131/E, M155/E	12
26189	400	MH 350W/400W/U/PS/740	ED37	Mogul (E39)	Clear	Universal	4000K	M131/E, M155/E	6
60260	400	MS 400W/H75/T15/S/PS/740	T15	Mogul (E39)	Clear	HOR±75°	4000K	M155/E	12
47815*		MH 400W/C/U/ED28/PS/737	ED28	Mogul (E39)	Coated	Universal	3700K	M155/E	12
90195	875	MH 875W/U/BT37/PS/740	BT37	Mogul (E39)	Clear	Universal	4000K	M166/E	6
49111	1000	MS 1000W/HOR/T25/PS/734	T25	Mogul POMB (EP39)	Clear	HOR±45°	3400K	M141/E	6
37999		MH 1000W/U/BT37/PS/740	BT37	Mogul (E39)	Clear	Universal	4000K	M141/E	6
71722*		MS 1000W/BU/BT37/PS/740	BT37	Mogul (E39)	Clear	BU±15°	4000K	M141/E	6
56999		MH 1000W/U/PS/740	BT56	Mogul (E39)	Clear	Universal	4000K	M141/E	6

### Enclosed Rated *Probe Start* Lamps

Order Code	Watts	Product Description	Bulb	Base	Bulb Finish	Operating Position	CCT	ANSI Code	Case Pack
63187	175	MH 175W/C/U/MED	ED17	Medium (E26)	Coated	Universal	3700K	M57/E	12
15556		MH 175W/U/MED	ED17	Medium (E26)	Clear	Universal	4000K	M57/E	12
96627		MH 175W/C/U	ED28	Mogul (E39)	Coated	Universal	3700K	M57/E	12
88791		MH 175W/U	ED28	Mogul (E39)	Clear	Universal	4000K	M57/E	12
33479	250	MH 250W/U/T15	T15	Mogul (E39)	Clear	Universal	4000K	M58/E	12
63052		MH 250W/U	ED28	Mogul (E39)	Clear	Universal	4000K	M58/E	12
55422	400	MH 400W/U/T15	T15	Mogul (E39)	Clear	Universal	4000K	M59/E	12
57540		MH 400W/U/ED28	ED28	Mogul (E39)	Clear	Universal	4000K	M59/E	12
83545		MH 400W/C/U	ED37	Mogul (E39)	Coated	Universal	3700K	M59/E	6
18520		MH 400W/U	ED37	Mogul (E39)	Clear	Universal	4000K	M59/E	6
64648	1000	MS 400W/C/HOR	ED37	Mogul POMB (EP39)	Coated	HOR±45°	3700K	M59/E	6
15332		MH 1000W/U/BT37	BT37	Mogul (E39)	Clear	Universal	4000K	M47/E	6
72051		MH 1000W/U	BT56	Mogul (E39)	Clear	Universal	4000K	M47/E	6

NOTE: \* Available while supplies last



# HID SPECIALIZED METAL HALIDE



## Super Pulse Start Long Life (SPL) Lamps

### Enclosed Rated SPL Lamps

Order Code	Watts	Product Description	Bulb	Base	Bulb Finish	Operating Position	CCT	ANSI Code	Case Pack
21982	100	MHL 100W/U/ED17/PS/740	ED17	Medium (E26)	Clear	Universal	4000K	M90/E	12
46105	150	MHL 150W/U/ED28/PS/740	ED28	Mogul (E39)	Clear	Universal	4000K	M102/E	12
98434	200	MHL 200W/V/ED28/PS/740	ED28	Mogul (E39)	Clear	V±15°	4000K	M136/E	12
46895	250	MHL 250W/V/ED28/PS/740	ED28	Mogul (E39)	Clear	V±15°	4000K	M153/E	12
65413		MHL 250W/H75/ED28/PS/740	ED28	Mogul (E39)	Clear	HOR±75°	4000K	M153/E	12
20116	320	MHL 320W/H75/ED28/PS/740	ED28	Mogul (E39)	Clear	HOR±75°	4000K	M154/E	12
68735	575	MHL 575W/BU/BT37/PS/740	BT37	Mogul (E39)	Clear	BU±15°	4000K	M178/E	6
20897		MHL 575W/H75/BT37/PS/740	BT37	Mogul (E39)	Clear	HOR±75°	4000K	M178/E	6

### Benefits and Features

- 40,000 hours rated life; up to twice the life of most regular Metal Halide products
- Quartz metal halide
- Excellent maintained lumens with up to 114 LPW
- Ultimate retrofit solution
- Cuts maintenance costs nearly in half, while doubling life and lumen maintenance



## Sports Lighting Lamps

### Enclosed Rated Sports Lighting Lamps

Order Code	Watts	Product Description	Bulb	Base	Bulb Finish	Operating Position	CCT	ANSI Code	Case Pack
47503	1000	MS 1000W/HOR/SPORT60	BT56	Mogul POMB (EP39)	Clear	HOR±60°	3400K	M47/E	6
12342	1500	MH 1500W/U/XL	BT56	Mogul (E39)	Clear	Universal	4000K	M48/E	6
18360		MH 1500W/HBU	BT56	Mogul (E39)	Clear	BU±105°	3400K	M48/E	6
82070	1650	MS 1500W/HOR/XP/SPORT60	BT56	Mogul POMB (EP39)	Clear	HOR±60°	3400K	M48/E	6
16419		MS 1650W/HOR/XP/SPORT60	BT56	Mogul POMB (EP39)	Clear	HOR±60°	3200K	M112/E	6

### Benefits and Features

- Brighter - High lumen output
- "Extra Life" lamp available - Venture's MH 1500W/U/XL lamp has a 6000 hour rated life
- Venture's Sports 60 lamps are designed for sports lighting aiming angles
- High lumen output lamps for efficient layout designs
- Good color rendition (65-70 CRI)



## Energy Master Energy Saving Retrofit Lamps

### Open Rated Energy Master Lamps ANSI Code M59/O and M155/O

Order Code	Watts	Product Description	Bulb	Base	Bulb Finish	Operating Position	CCT	Replaces Existing Wattage	Watts Saved	Case Pack
91844	330	MPI 330W/C/BU/EM	ED37	Mogul (EX39)	Coated	BU±15°	3700K	400W	70	6
91834		MPI 330W/BU/EM	ED37	Mogul (EX39)	Clear	BU±15°	4000K	400W	70	6

### Benefits and Features

- Just change the lamp not the ballast
- Save energy; Up to \$25.50 annually per lamp
- Open rated lamps available in 330W and 360W

### Open Rated Energy Master Lamps ANSI Code M59/O and M165/O

Order Code	Watts	Product Description	Bulb	Base	Bulb Finish	Operating Position	CCT	Replaces Existing Wattage	Watts Saved	Case Pack
67293	360	MPI 360W/C/BU/EM	BT37	Mogul (EX39)	Coated	BU±15°	3700K	400W	40	6
38029		MPI 360W/BU/EM	BT37	Mogul (EX39)	Clear	BU±15°	4000K	400W	40	6

### Enclosed Rated Energy Master Lamps ANSI Code M57/E and M107/E

Order Code	Watts	Product Description	Bulb	Base	Bulb Finish	Operating Position	CCT	Replaces Existing Wattage	Watts Saved	Case Pack
44810	150	MH 150W/U/EM	ED17	Medium (E26)	Clear	Universal	4000K	175W	25	12
69559		MH 150W/U/ED28/EM	ED28	Mogul (E39)	Clear	Universal	4000K	175W	25	12



# HID SPECIALIZED METAL HALIDE



## Natural White® PS MH, 5000K, 90+ CRI

### Open Rated Natural White® Lamps

Order Code	Watts	Product Description	Bulb	Base	Bulb Finish	Operating Position	CCT	ANSI Code	Case Pack
19523	250	MP 250W/BU/PS/EM/950	ED28	Mogul (EX39)	Clear	BU±15°	5000K	M153/O	12
95320	320	MP 320W/H75/T15/S/PS/EM/950	T15	Mogul (EX39)	Clear	HOR±75°	5000K	M154/O	12
95321		MP 320W/H75/T15/L/PS/EM/950	T15	Mogul (EX39)	Clear	HOR±75°	5000K	M154/O	12
51628	350	MP 350W/BU/PS/EM/950	ED37	Mogul (EX39)	Clear	BU±15°	5000K	M131/O	6
57129	400	MP 400W/BU/PS/EM/950	ED37	Mogul (EX39)	Clear	BU±15°	5000K	M155/O	6
95575	575	MP 575W/BU/BT37/PS/EM/950	BT37	Mogul (EX39)	Clear	BU±15°	5000K	M178/O	6
24983	775	MP 775W/BU/BT37/PS/950	BT37	Mogul (EX39)	Clear	BU±15°	5000K	M181/O	6
24988		MP 775W/BD/BT37/PS/950	BT37	Mogul (EX39)	Clear	BU±15°	5000K	M181/O	6

### Benefits and Features

- Crisp, bright light with 5000K CCT and 90+ CRI
- 90% maintained lumens (0.90 LLD)
- 14% Perceivable brighter light
- Extreme long life at 26,000 - 40,000 hours

### Enclosed Rated Natural White® Lamps

Order Code	Watts	Product Description	Bulb	Base	Bulb Finish	Operating Position	CCT	ANSI Code	Case Pack
95577	575	MS 575W/H75/BT37/PS/EM/950	BT37	Mogul (E39)	Clear	HOR±75°	5000K	M178/E	6
24999	775	MS 775W/H75/BT37/PS/950	BT37	Mogul (E39)	Clear	HOR±75°	5000K	M181/E	6



## White-Lux Metal Halide Retrofit HPS Lamps

### Open Rated White-Lux Lamps

Order Code	Watts	Product Description	Bulb	Base	Bulb Finish	Operating Position	CCT	ANSI Code	Case Pack
24785	250	MPI 250W/BU/LU	ED28	Mogul (EX39)	Clear	BU±15°	4000K	S50/O	12
10044	400	MPI 400W/BU/LU	ED37	Mogul (EX39)	Clear	BU±15°	4000K	S51/O	6

### Benefits and Features

- Replace yellow HPS lamps with white MH lamps
- Just change the lamp not the ballast
- Electrical and photometric compatibility with HPS systems
- Clear and coated outer jacket options

### Enclosed Rated White-Lux Lamps

Order Code	Watts	Product Description	Bulb	Base	Bulb Finish	Operating Position	CCT	ANSI Code	Case Pack
91051	250	MH 250W/U/LU	ED28	Mogul (E39)	Clear	Universal	4000K	S50/E	12
59441	400	MH 400W/U/LU/ED28	ED28	Mogul (E39)	Clear	Universal	4000K	S51/E	12
52134		MH 400W/U/LU	ED37	Mogul (E39)	Clear	Universal	4000K	S51/E	6



## Double Ended Metal Halide Lamps

### Enclosed Rated Double Ended Lamps

Order Code	Watts	Product Description	Bulb	Base	Bulb Finish	Operating Position	CCT	ANSI Code	Case Pack
16786	70	MH-DE 70W/UVS/3K	T6	RSC (R7s)	Clear	HOR±45°	3000K	M85/E	25
60248		MH-DE 70W/UVS/4K	T6	RSC (R7s)	Clear	HOR±45°	4200K	M85/E	25
11295		MH-DE 150W/UVS/3K	T7	RSC (R7s)	Clear	HOR±45°	3000K	M81/E	25
74756	150	MH-DE 150W/UVS/4K	T7	RSC (R7s)	Clear	HOR±45°	4200K	M81/E	25
29963		MH-DE 150W/UVS/FS/6K	T7	RSC (R7s)	Clear	HOR±45°	6500K	M81/E	25
84727	250	MH-DE 250W/UVS/3K/FC2	T8	Fc2	Clear	HOR±45°	3000K	M80/E	25
72748		MH-DE 250W/UVS/4K/FC2	T8	Fc2	Clear	HOR±45°	4200K	M80/E	25
22417	1000	MBIL S 1000W	T5	RSC (Rx7s)	Frosted	HOR±15°	5200K	M___/F	6
22151	1500	MBIL S 1500W	T7	RSC (Rx7s)	Frosted	HOR±15°	5200K	M133/F	6
22528		MH-DE 1500W/T8/F	T8	Spade Connector	N/A	HOR±15°	4200K	M133/F	2
22132		2000	MBIL S 2000W	T8	Contact Factory	Frosted	HOR±15°	5200K	M134/F

### Benefits and Features

- Available in 70W - 250W and 1000W - 2000W
- Low wattage lamps have compact configuration which provides excellent optical control in smaller fixture designs
- High wattage lamps are used for large area floodlighting and sports lighting applications



# HID HIGH PRESSURE SODIUM LAMPS



## High Pressure Sodium Lamps

### Enclosed Rated *High Pressure Sodium Lamps*

Order Code	Watts	Product Description	Bulb	Base	Bulb Finish	Operating Position	CCT	ANSI Code	Case Pack
23002	50	LU50/MED/ECO	E17	Medium (E26)	Clear	Universal	2100K	S68	12
23004	70	LU70/MED/ECO	E17	Medium (E26)	Clear	Universal	2100K	S62	12
23012		LU70/ECO	E23.5	Mogul (E39)	Clear	Universal	2100K	S62	12
23006	100	LU100/MED/ECO	E17	Medium (E26)	Clear	Universal	2100K	S54	12
23007		LU100/D/MED	E17	Medium (E26)	Coated	Universal	2100K	S54	12
23014		LU100/ECO	E23.5	Mogul (E39)	Clear	Universal	2100K	S54	12
23008	150	LU150/55/MED/ECO	E17	Medium (E26)	Clear	Universal	2100K	S55	12
23016		LU150/55/ECO	E23.5	Mogul (E39)	Clear	Universal	2100K	S55	12
23019	250	LU250/ECO	ED18	Mogul (E39)	Clear	Universal	2100K	S50	36
23022	400	LU400/ECO	ED18	Mogul (E39)	Clear	Universal	2100K	S51	36
23025	1000	LU1000/ECO	ED25	Mogul (E39)	Clear	Universal	2100K	S52	12

ED17



E23.5



ED18



E25



# HID BALLASTS



## Metal Halide Standard and Pulse Start Ballast Kits

Order Code	Watts	Product Description	Voltage (60Hz)	ANSI Code	Core
V90D5833K	70	70W PSMH QUAD HX	120/208/240/277	M98	3X4
V90D5932K	100	100W PSMH QUAD HX	120/208/240/277	M90	3X4
V90J8811K	125	125W PSMH TRI CWA	120/277/347	M150	3X4
V90D7130K	150	150W PSMH QUAD HX	120/208/240/277	M102	3X4
V90D6112K	175	175W MH QUAD CWA	120/208/240/277	M57	3X4
V90J6112K		175W MH TRI CWA	120/277/347	M57	4X4
V90D6215K	250	250W MH QUAD CWA	120/208/240/277	M58	4X4
V90J6215K		250W MH TRI CWA	120/277/347	M58	4X4
V90D8411K		250W PSMH QUAD CWA	120/208/240/277	M153	4X4
V90D8412K		250W PSMH QUAD CWA	120/208/240/277	M153	4X4
V90D7413K	320	320W PSMH QUAD CWA	120/208/240/277	M154	4X4
V90D7513K	350	350W PSMH QUAD CWA	120/208/240/277	M131	4X4
V90AM6411K	400	400W MH QUINT CWA	120/208/240/277/480	M59	4X4
V90J6414K		400W MH TRI CWA	120/277/347	M59	4X4
V90AM7610K		400W PSMH QUINT CWA	120/208/240/277/480	M155	4X4
V90D7613K		400W PSMH QUAD CWA	120/208/240/277	M155	4X4
V90J7612K		400W PSMH TRI CWA	120/277/347	M155	4X4
V90J8511K	450	450W PSMH TRI CWA	120/277/347	M144	4X4
V90AM5510K	575	575W PSMH QUINT CWA	120/208/240/277/480	M178	4X4
V90D5510K		575W PSMH QUAD CWA	120/208/240/277	M178	4X4
V90AM6514K	1000	1000W MH QUINT CWA	120/208/240/277/480	M47	4X6
V90J6517K		1000W MH TRI CWA	120/277/347	M47	4X6
V90AM7810K		1000W PSMH QUINT CWA	120/208/240/277/480	M141	4X6
V90D6612K	1500	1500W MH QUAD CWA	120/208/240/277	M48	4X6

## HPS Ballast Kits

Order Code	Watts	Product Description	Voltage (60Hz)	ANSI Code	Core
V90D1233K	70	70W HPS QUAD HX	120/208/240/277	S62	3X4
V90B1322Ki	100	100W HPS 120 RCTR	120	S54	E&I
V90D1333K		100W HPS QUAD HX	120/208/240/277	S54	3X4
V90D1435K	150	150W HPS QUAD HX	120/208/240/277	S55	3X4
V90J1434K		150W HPS TRI HX	120/277/347	S55	3X4
V90AM1710K	250	250W HPS QUINT CWA	120/208/240/277/480	S50	4X4
V90J1711K		250W HPS TRI CWA	120/277/347	S50	4X4
V90AM1910K	400	400W HPS QUINT CWA	120/208/240/277/480	S51	4X4
V90J1911K		400W HPS TRI CWA	120/277/347	S51	4X4

Notes: All ballast kits are sold individually boxed and include prewired capacitor & ignitor (when required) plus universal mounting brackets

## Capacitors

Product Code	Type	Micro-Farads	VAC
ACG033	Dry Film	6	330
ACG310	Dry Film	8	280
ACG279	Dry Film	10	400
ACG321	Dry Film	12	330
ACG277	Dry Film	15	400
ACG301	Dry Film	16	330
ACB3270V	Oil Cap	22	525
ACG247	Dry Film	24	400
ACB2200V	Oil Cap	24	480
ACG278	Dry Film	26	400
ACB2640V	Oil Cap	26	525
ACB2560V	Oil Cap	32	525
ACG255	Dry Film	55	300

## Replacement Ignitors

Product Code	Product Description
BVS004A	35-150W HPS REACTOR
BVS005A	200-430W HPS
BVS006A	35-150W HPS
BVS020	875-1000W HPS/PSMH
BVS032	Low Watt PSMH HX
BVS041	Mid Watt PSMH CWA

## Replacement Sockets

Standard medium and mogul enclosed-rated (E26, E39), open-rated (EX26, EX39), and position oriented mogul (EP39) bases are available. Contact Venture Lighting for more information.

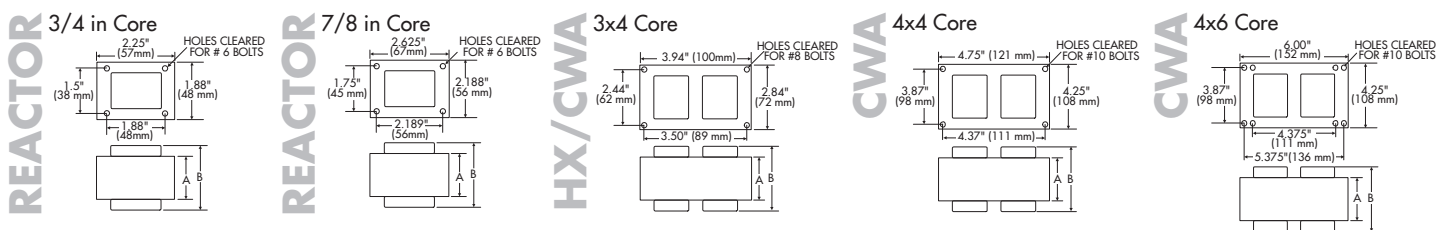

# HID TECHNICAL INFORMATION

## Proper Use of Metal Halide Lamps

### Correct Operation and Warnings For High Intensity Discharge Lamps:

High intensity discharge (HID) lamps require auxiliary equipment (ballasts, capacitors and ignitors) to provide the correct electrical values for starting and operating. This auxiliary equipment shall meet the requirements of all relevant Venture specifications, NEMA/ANSI standards and safety standards. Venture Lighting International is not responsible for poor performance, personal injury, property damage, burns or fire from lamps operating on unapproved auxiliary equipment or from lamps being operated in a manner inconsistent with the lamp design.

Power should always be turned off, and preferably locked out, in accordance with OSHA guidelines whenever installation, removal or maintenance is performed on lighting systems. Safety glasses and gloves should be used when installing or removing HID lamps. Lamps should be installed firmly into appropriate lamp sockets, without over-tightening, to avoid loosening from vibration.

HID lamps and arc tubes operate at extremely high temperatures and may shatter as a result of misapplication, system failure or other factors. Scratches on the outer bulb, direct contact with water or excessive installation pressure can cause lamps to break. Breakage may release extremely hot glass and lamp parts into the surrounding environment and raise the risk of fire, personal injury or property damage. Injury may also be caused by ultraviolet energy from an unjacketed HID lamp. If the outer jacket should break, immediately turn the power off. Do not remove a lamp until it is completely cooled; then replace it with a new Venture Lighting® lamp. In areas susceptible to contamination by flying glass, where flammable materials are present, or where there is a possibility of personal injury, users should seek additional protective measures by using open fixture (Type-0) lamps and enclosed luminaires.

### Luminaire Requirements and Operating Positions

It is imperative that users adhere to specified luminaire and lamp operating positions and requirements. The operation of lamps in positions other than those specified can result in severe reductions in lamp performance, including lamp life, light output and color. Incorrect operating positions can also create the possibility of an early failure.

Refer to each lamp's technical data specification sheet to determine the correct operating position and luminaire requirements. Also, refer to the diagrams on this page to determine allowable operating positions.

### Federal Compliance - Metal Halide Lamps:

Venture Lighting lamps comply with USA Federal Standard 21 CFR 1040.30 and Canada Standard SOR/80-381. The FDA requires the following safety warning statement for all metal halide lamps:

“WARNING: This lamp can cause serious skin burn and eye inflammation from shortwave ultraviolet radiation if outer envelope of the lamp is broken or punctured and the arc tube continues to operate. Do not use where people will remain for more than a few minutes, unless adequate shielding or other safety precautions are used. Lamps that will automatically extinguish when the outer envelope is broken or punctured are commercially available.”

Careful adherence to the previously mentioned precautions may not eliminate all possible risks associated with the use of metal halide lamps, but it will reduce the likelihood of personal injury or property damage.

### Warning Notices:

WARNING: THESE INSTRUCTIONS MUST BE FOLLOWED TO AVOID POSSIBLE EARLY FAILURE OF THE LAMP. Venture Lighting will not be responsible for poor lamp performance, personal injury, property damage, burns or fire resulting from failure to follow these instructions.

- Operate lamp in the specified burning position with compatible electrical equipment. The ANSI code on the Venture lamp must match the code on the ballast or luminaire. If in doubt, consult with Venture Lighting or the luminaire manufacturer.
- Operate pulse start metal halide lamps with appropriate pulse start metal halide ballasts and lampholders that can withstand a 4000 volt pulse. The substitution of standard probe start (non-pulse start) metal halide lamps will result in poor performance and is not recommended.
- Operate high pressure sodium lamps with appropriate high pressure sodium ballasts and lampholders that can withstand a 4000 volt pulse (except 600W, 750W, and 1000W lamps which require lampholders that can withstand a 5000 volt pulse).
- Electrically insulate any metal bulb supports in the luminaire to avoid decomposition of glass.
- Protect lamp from direct contact with rain, sleet or snow to avoid breakage from thermal shock.
- This is a vacuum-jacketed lamps and may implode if broken; avoid skin contact with broken lamp pieces. Wear safety glasses and gloves when installing or removing high intensity discharge lamps.
- Install lamp firmly, but not forcibly, into the socket to minimize loosening from vibration.
- Do not use excessive force as the glass bulb may break.
- During lamp replacement, turn power off and let lamp cool before removal to avoid potential electrical shock and/or burns.

- Replace bulb if scratched, cracked or damaged.
- If the outer envelope breaks or is punctured and lamp continues to operate, immediately turn power off and remove lamp after it has cooled.

### Positions of Operation



Universal  
Any Position



Vertical  $\pm 15^\circ$



HOR  $\pm 15^\circ$   
Horizontal



HOR  $\pm 45^\circ$   
Horizontal



HOR  $\pm 60^\circ$   
Horizontal



H  $\pm 75^\circ$   
Horizontal



BU  $\pm 15^\circ$   
Base Up



BU  $\pm 90^\circ$   
Base Up



BU  $\pm 105^\circ$   
Base Up



## End-of-Life and Reduction of Risk

At end-of-life, the vast majority of metal halide lamps will simply fail by not reigniting. On rare occasions, metal halide lamps may fail in a violent manner. The possibility of this type of failure is significantly reduced by group re-lamping at or before the rated end of life (see Group Re-lamping). In any application where enclosed rated (Type-E) lamps are operated continuously (24 hours per day, seven days per week), the lamps should always be turned off for a period of at least 15 minutes each week; this precaution can reduce the possibility of violent failures. This procedure is not required with Venture's open rated (ANSI Type-O) shrouded lamps. These lamps are easily identified by the prefix "MP," "MPI," "MPL," "MPE," "MPSE" or "MPC" in the lamp description code.

## Starting and Restarting Characteristics

Venture's Uni-Form® pulse start metal halide lamps start at an ambient temperature of -40°C (-40°F) or higher. Full light output does not occur immediately when power is applied to any metal halide lamp; after starting, there is a time delay of at least three to six minutes before lamps reach full light output.

After lamps have started, a power interruption of 1/4 cycle (1/240th of a second) or more may cause the lamps to extinguish. Several minutes are required before an arc can be re-established by the ballast and full light output achieved. The exact time is dependent on a number of

factors including lamp wattage, ballast and ignitor characteristics, ambient temperature, fixture dimensions and supply voltage.

The time needed to establish full light output can be as short as three minutes and as long as 15 to 20 minutes. Venture's exclusive Uni-Form formed-body arc tube provides warm-up and hot re-strike in up to 60% less time than standard probe start metal halide lamps.

## Lamp Life

Lamp life is an important consideration when purchasing a new, retrofit or replacement lamp. Two very different and distinct terms describe life: "rated life" and "economic life."

### Rated Life

Rated life for metal halide lamps is a value of lamp life expectancy based on laboratory and field tests of representative lamps, operating on approved ballasts, with a burn cycle of at least 10 hours per start. The lamp life is determined when 50% of metal halide lamps initially installed are still operating

### Operating Position

Various operating conditions affect lamp life. One key factor is operating position. Position-oriented lamps (designed to operate in one specific position) are tested and rated based on that designated position; operating these lamps in any other position can dramatically shorten life, reduce lumen output and cause color shift. Lamps designated universal can be operated in any position, however, life expectancy and lumen output are sacrificed in certain positions;

published "rated life" for universal lamps is based on operation in the vertical position, "rated life" for universal lamps operated horizontally is 75% of the published rating.

### Economic Life

Economic life refers to the hours of operation during which a lamp is designed to provide optimum light output and color quality as well as lowest replacement cost. Economic life describes actual lamp life better than rated life because rated life does not account for the lumen depreciation and color shift that occur as lamps age. The economic life of lamps is generally 60% to 75% of the lamp rated life. Though economic life is important when considering a lighting system, lamp data tables show rated life because they provide a comparison with other lamp manufacturers' ratings.

**Lamp Mortality & Maintenance Curves**

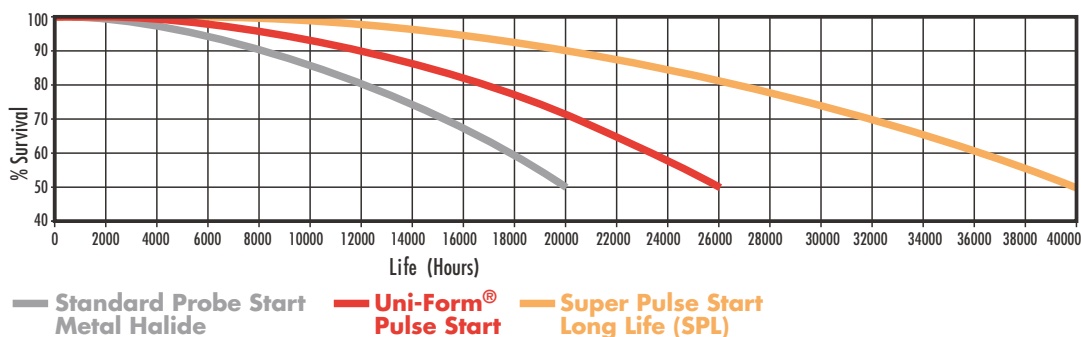
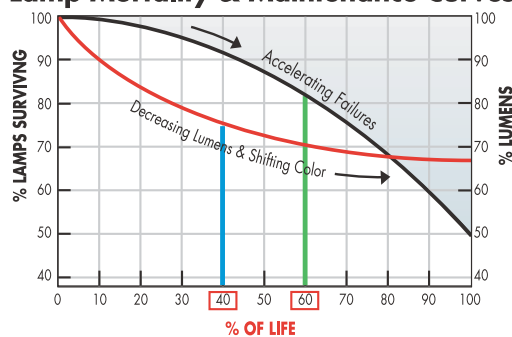

## Group Relamping Effective Lighting Management

Group re-lamping offers significant savings in time and labor costs over spot replacing single failed lamps. Regularly scheduled maintenance based on economic lamp life keeps a lighting system functioning at its maximum.

This provides:

### 1) Optimum Light Output:

Light levels are at peak performance when a lighting installation is new. Many standard probe start metal halide lamps decrease to as low as 25% of initial light output by the end of rated life. A number of factors may accelerate this reduction in efficacy (lumens per watt). Group re-lamping at economic life keeps the light levels from dropping significantly; it also provides an opportunity to remove dirt accumulation in the luminaire. Cleaning during group re-lamping saves time and helps maintain optimum light levels. A cleaner, well-lit environment increases safety and security, contributes to higher worker productivity and creates a better impression for visitors.

### 2) Aesthetic Quality:

The quality of light changes over economic life; most of this shift occurs in the last 25% of rated life. This causes old lamps to appear blue or pink, especially when compared to new lamps. All the lamps in an area will generally change color together. However, lamps that are spot replaced will look noticeably different than those around them.

### 3) Optimum Energy Efficiency:

While the light output of a metal halide lamp decreases over the life span, the lamp will still consume the same (or sometimes more) electricity. Since energy is the largest cost of lighting, group re-lamping prevents almost half of the energy from being wasted by under-performing lamps. For example, a 400 watt lamp may consume \$800 of electricity over its rated life. After 60% of rated life, about \$320 is wasted on lamps providing less than mean lumens. Spot re-lamping wastes energy dollars; the cost of a new lamp and the labor to install it as part of group re-lamping is generally less than 5% of the total energy cost.

### 4) Cost Effective Replacement:

Group re-lamping, as a planned maintenance program, reduces labor costs and interference with facility operations. Spot re-lamping often takes an employee away from regular duties to replace a single burned out lamp; this inconvenience grows as lamp failures increase towards the end of rated life. Group re-lamping eliminates workday disruptions, allowing re-lamping to take place during normal shutdown periods. Also, group re-lamping at economic life is a practical way to sustain workers' visual acuity with a bright workplace environment.

## MAINTENANCE PROGRAM TYPICAL LAMP LUMEN PERFORMANCE

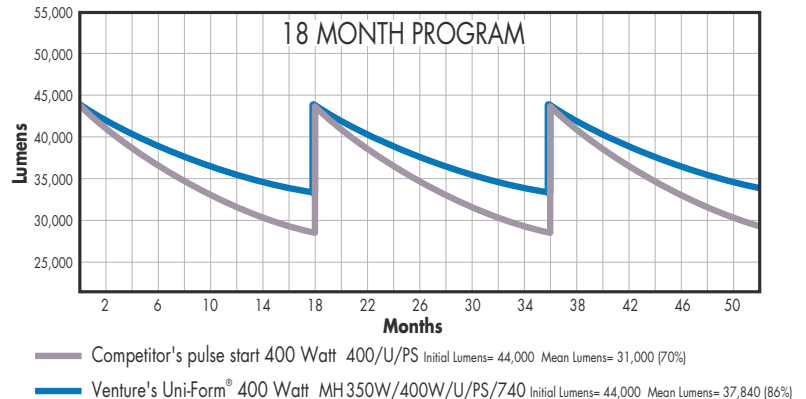

## MAINTENANCE PROGRAM TYPICAL LAMP LUMEN PERFORMANCE

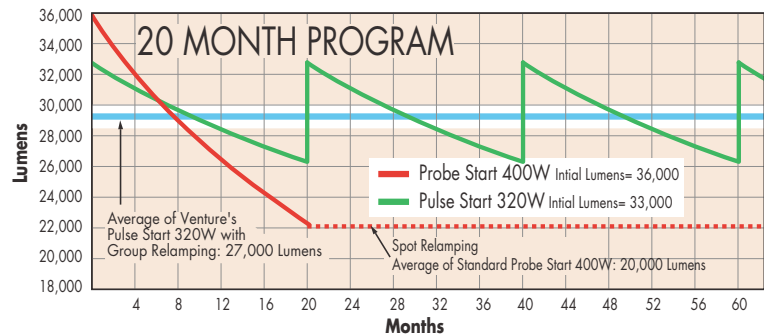



## Group Relamping Effective Lighting Management

Group re-lamping offers significant savings in time and labor costs over spot replacing single failed lamps.

### Open Rated Lamps

Open luminaires offer significant advantages over enclosed luminaires. They do not require cover lenses which reduce light output and accumulate dirt. In addition, enclosed luminaires make lamp replacements more difficult. For safety, open luminaires need open rated (ANSI Type-O) metal halide lamps.

To reduce the risk of liability, lighting specifiers need to be aware of the criteria for a true open rating and what the Type-S or Type-O designations indicate about lamp construction.

### ANSI Lamp Designations

The American National Standards Institute (ANSI) currently classifies metal halide lamps with three possible ratings: Type-O, Type-S and Type-E.

**Type-O** open fixture rated lamps characteristics:

1. There is a shroud around the arc tube, which helps prevent damage to the outer bulb in the event of an arc tube rupture.

2. The base is open fixture rated, such as an EX39 mogul base or narrow neck bulb with a medium base, both of which require special exclusionary sockets.

3. They pass the ANSI C78.389 lamp containment test, where arc tubes are forcibly ruptured and must be contained within the outer jacket.

All "MP," "MPI," "MPL," "MPE," "MPSE" and "MPC" lamps produced by Venture Lighting meet the requirements to be rated Type-O and can be used with confidence.

**Type-S** lamps do not include internal protection against failure. These lamps are not permitted in new open luminaires, according to UL1598 and the NEC.

**Type-E** lamps are rated for use only in enclosed luminaires.

#### Type-O

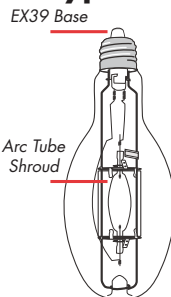

#### Type-E, S

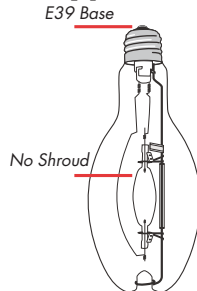

In September 2010, UL1598 became effective with requirements for open metal halide luminaires and Type-O lamps. These requirements are the same as those in the 2005 National Electrical Code (NEC) published by the National Fire Protection Agency (NFPA).

NEC section 410.73(F)(5) states that "Luminaires (fixtures) that use a metal halide lamp other than a thick-glass parabolic reflector lamp (PAR) shall be provided with a containment barrier that encloses the lamp, or shall be provided with a physical means that only allows the use of a lamp that is Type-O."

Open luminaires require sockets that only accept Type-O lamps (pink EX39 mogul sockets or E26 narrow neck medium sockets) in order to prevent accidental use of Type-S or Type-E lamps.

### We Build Lighting Systems With Safety in Mind!

For over 20 years, Venture has been leading the way by producing metal halide lamps that contain protective shrouds. Venture Lighting provides the industry's widest selection of lamps that meet ANSI C78.389 testing requirements for a rating of Type-O. Venture is building lighting systems with the safety of you and your customers in mind.

### Venture's Open Rated Lamp Benefits

Venture's MP, MPI, MPL, MPE, MPSE and MPC lamps:

- Meet requirements of the UL1598 and the National Electric Code
- Meet ANSI criteria for a Type-O rating
- No luminaire lens required, delivering more light - Lumen loss with a lens is up to 16%
- Can be operated continuously; no shut off required
- Contain shrouds with most wattages
- Operate in open or enclosed luminaires



Ruptured arc tube contained within the intact outer jacket of a Venture MP lamp



#### Footnotes:

1. NEMA white paper: LSD 71-2020
2. FMGlobal Property Loss Prevention Data Sheets, 5-21, Rev. May 2001.



# WARRANTY INFORMATION

## LED Lamps and Retrofit Kits Warranty Information

This Venture Lighting product is warranted for the period of 5 years, as specified, from the date of purchase against defects in material and workmanship. The determination of whether the product is defective shall be made by Venture Lighting.

This limited warranty shall only apply if the Venture Lighting product has been installed and operated (i) in

LED Product Type	Rated Life	Warranty Period	Usage
LED T8 Lamps	50,000 hrs	5 years	12 hrs/day annually
LED Retrofit Lamps	50,000 hrs	5 years	12 hrs/day annually
LED Downlight Kits	35,000 hrs	5 years	12 hrs/day annually

compliance with the specifications and guidelines set forth herein, on the product label and packaging, and on the Venture Lighting website, (ii) in accordance with the National Electric Code (NEC), the Standards for Safety of Underwriters' Laboratory, Inc. (UL), the Standards for the American National Standards Association (ANSI), or in Canada, with the standards of the Canadian Standards Association (CSA), and (iii) in lighting equipment designed and approved for the application and in environmental conditions within the normal specified operating range of the product.

This limited warranty does not apply to loss or damage to the product caused by: negligence; abuse; misuse; mishandling; improper installation, storage, or maintenance; damage due to fire or acts of God; vandalism; civil disturbances; power surges; improper power supply; electrical current fluctuations; corrosive environment installations; induced vibration; harmonic oscillation or resonance associated with the movement of air currents around the product; alteration; accident; failure to follow installation, operating, maintenance or environmental instructions.

The warranty terms contained herein shall be the sole and exclusive remedy of the purchaser of Venture Lighting products and state Venture Lighting's entire liability and obligation to such purchaser. NO WARRANTY OF FITNESS FOR ANY SPECIFIC OR PARTICULAR PURPOSE IS MADE OR IS TO BE IMPLIED. NO OTHER WARRANTIES APPLY.

If the product is defective, this product will be repaired or replaced, at Venture Lighting's option. This warranty is expressly limited to the repair or replacement of the product. This warranty gives the customer specific legal rights, which vary from state to state and province to province. No distributor, salesperson, dealer, retailer or other representative has the authority to change or modify this warranty, either orally or in writing, in any respect.

WARRANTY IS VOID IF PRODUCT IS NOT USED FOR THE PURPOSE FOR WHICH THIS PRODUCT IS DESIGNED.

## LED Fixtures Warranty Information

This Venture Lighting product is warranted for the period of 5 years, as specified, from the date of purchase against defects in material and workmanship. The determination of whether the product is defective shall be made by Venture Lighting. A Venture Lighting product will not be considered defective under this warranty solely because a small number of separate LED components fail to operate (i.e. provide light) when the number of such failed components is less than 10% of the total number of light emitting components which are part of the product.

This limited warranty shall only apply if the Venture

Lighting product has been installed and operated (i) in compliance with the specifications and guidelines set forth herein, on the product label and packaging, and on the Venture Lighting website, (ii) in accordance with the National Electric Code (NEC), the Standards for Safety of Underwriters' Laboratory, Inc. (UL), the Standards for the American National Standards Association (ANSI), or in Canada, with the standards of the Canadian Standards Association (CSA), and (iii) in lighting equipment designed and approved for the application and in environmental conditions within the normal specified operating range of the product.

This limited warranty does not apply to loss or damage to the product caused by: negligence; abuse; misuse; mishandling; improper installation, storage, or maintenance; damage due to fire or acts

of God; vandalism; civil disturbances; power surges; improper power supply; electrical current fluctuations; corrosive environment installations; induced vibration; harmonic oscillation or resonance associated with the movement of air currents around the product; alteration; accident; failure to follow installation, operating, maintenance or environmental instructions.

The warranty terms contained herein shall be the sole and exclusive remedy of the purchaser of Venture Lighting products and state Venture Lighting's entire liability and obligation to such purchaser. NO WARRANTY OF FITNESS FOR ANY SPECIFIC OR PARTICULAR PURPOSE IS MADE OR IS TO BE IMPLIED. NO OTHER WARRANTIES APPLY.

If the product is defective, this product will be repaired or replaced, at Venture Lighting's option. This warranty is expressly limited to the repair or replacement of the product. This warranty gives the customer specific legal rights, which vary from state to state and province to province. No distributor, salesperson, dealer, retailer or other representative has the authority to change or modify this warranty, either orally or in writing, in any respect. WARRANTY IS VOID IF PRODUCT IS NOT USED FOR THE PURPOSE FOR WHICH THIS PRODUCT IS DESIGNED.

## Poles Warranty Information

See Venture Lighting's website for pole warranty information

## HID Lamp Warranty Information

1. Upon receipt and/or initial installation by the customer, Venture Lighting International will replace any lamp determined to be defective in materials, workmanship, or proper operating parameters.

2. Venture Lighting will replace any lamp that fails within one year from the purchase date (based on 5000 hrs./yr. operation) when the failure is determined to be lamp related (applies to lamps with life ratings of greater than 7500 hrs.).

3. During economic life, Venture Lighting will supply replacement lamps for failed lamps in excess of the failure rate projected by life expectancy curves, when the lamps are operated correctly and in accordance with the guidelines outlined in this technical guide.

All performance ratings are based on lamp testing at rated watts, under controlled conditions, using primary AC electrical circuits with the highest quality auxiliary equipment. The performance of any lamp may vary somewhat under typical service conditions. All lamp specifications and ratings are subject to change without notice.

## Limited Warranty on HID Ballasts

Venture® ballast products are warrantied free from manufacturing and workmanship defects for a period of two years from the date of shipment. During this period, Venture will, at its option, repair or replace ballast products which prove to be defective or out of specification. This warranty is granted by Venture only to the original purchaser or first end-user of such ballast products.

HID Product Type	Warranty Period
Lamps	One Year
All SPL Lamps	Two Years
Magnetic Ballasts	Two Years

This warranty is conditional upon installation, maintenance and operation in accordance with Venture's instructions and specifications set forth in the purchase order or contract at the time of order and in accordance with the standards of The National Electric Code (NEC), Underwriters' Laboratory, Inc. (UL) and the American National Standards Institute (ANSI) and, in Canada, with the standards of the Canadian Standards Association (CSA). Damage by misuse or abnormal conditions of storage, installation, maintenance or operation, including, but not limited to, excessive temperatures or evidence of partial or complete disassembly beyond normal maintenance or expansion procedure void this warranty in its entirety. The conditions of any tests performed concerning any ballast product claimed to be defective in accordance with the terms of this warranty shall be mutually agreed upon in writing between the original purchaser or first end-user and Venture and Venture may be represented at any such test.

No implied statutory warranty of merchantability or fitness for a particular purpose shall apply beyond the afore-mentioned warranty period. This warranty excludes other warranties, expressed or implied and is the exclusive remedy of the claimant. Venture shall not be liable for any special, indirect or consequential damages. Venture's liability on any claim of any kind, nature or description arising out of, resulting from or concerning any aspect of this warranty agreement or from the product or services furnished hereunder shall not exceed the price of the specific ballast or ballasts which give rise to the claim. For warranty service or repair, the buyer shall prepay all shipping charges to Venture and Venture shall pay shipping charges to return the repaired or replaced item to the buyer. However, the buyer shall pay all shipping charges, duties and taxes for products returned to Venture from a country other than that of the United States of America.

## HID Product replacement/liability limits

The foregoing warranty shall be the sole and exclusive remedy of the purchaser and Venture's sole and exclusive remedy to the purchaser. NO WARRANTY OF FITNESS FOR ANY SPECIFIC OR PARTICULAR PURPOSE IS MADE OR IS TO BE IMPLIED. NO OTHER WARRANTY APPLIES. Venture will not, under any circumstance, whether as a result of breach of contract, warranty tort or otherwise, be liable for any costs or damages, including lost profits or revenues, incidental, special or consequential damages.

Some states or provinces do not allow the exclusion or limitation of incidental or consequential damages, so the above limitation or exclusion may not apply to you. This warranty gives you specific legal rights, and you may also have other rights which may vary from state to state and province to province. No distributor, salesperson, dealer, retailer or other representative has the authority to change or modify this warranty, either orally or in writing, in any respect.





# VALUE • FLEXIBILITY • PERFORMANCE

## 2024 CATALOG

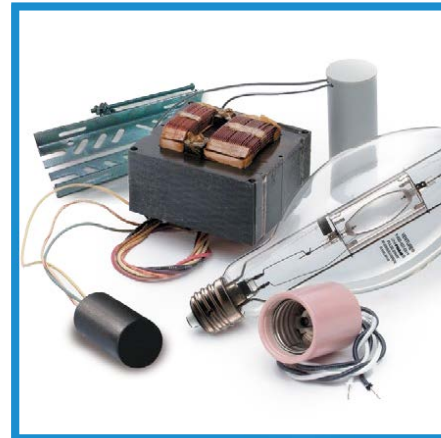

## LED • CONTROLS • HID

**(800) 451-2606**

6675 Parkland Blvd., Suite 100  
Solon, Ohio 44139 USA

E-mail: [Venture\\_Lighting@VentureLighting.com](mailto:Venture_Lighting@VentureLighting.com)

**VentureLighting.com**

**CANADA**

2848 Slough St.  
Mississauga, ON  
Canada L4T 1G3

Email: [canadaorders@venturelighting.com](mailto:canadaorders@venturelighting.com)



**VENTURE**  
LIGHTING